



MODEL:

TANK-860-HM86 Series

Embedded System with 4th Generation Intel® Core™ processor,
VGA, DVI-I, DisplayPort, Two Gigabit Ethernet,
Four USB 3.0, Two USB 2.0, RS-232/422/485,
RoHS Compliant

User Manual

Revision

Date	Version	Changes
26 March 2015	1.03	Update P.N of system fan Add connector pinouts of backplane
12 March 2015	1.02	Update P.N of Power Adapter (150W)
19 December 2014	1.01	Update Section 1.8: Backplane Options
14 November 2014	1.00	Initial release

Copyright

COPYRIGHT NOTICE

The information in this document is subject to change without prior notice in order to improve reliability, design and function and does not represent a commitment on the part of the manufacturer.

In no event will the manufacturer be liable for direct, indirect, special, incidental, or consequential damages arising out of the use or inability to use the product or documentation, even if advised of the possibility of such damages.

This document contains proprietary information protected by copyright. All rights are reserved. No part of this manual may be reproduced by any mechanical, electronic, or other means in any form without prior written permission of the manufacturer.

TRADEMARKS

All registered trademarks and product names mentioned herein are used for identification purposes only and may be trademarks and/or registered trademarks of their respective owners.

Table of Contents

1 INTRODUCTION	1
1.1 OVERVIEW.....	2
1.2 MODEL VARIATIONS.....	3
1.3 FEATURES.....	3
1.4 TECHNICAL SPECIFICATIONS.....	4
1.5 FRONT PANEL.....	6
1.5.1 TANK-860-HM86-2 slot Front Panel.....	6
1.5.2 TANK-860-HM86-4 slot Front Panel.....	8
1.5.3 TANK-860-HM86-6 slot Front Panel.....	10
1.6 REAR PANEL.....	11
1.7 LED INDICATORS.....	12
1.8 BACKPLANE OPTIONS.....	14
1.9 PHYSICAL DIMENSIONS.....	23
1.9.1 TANK-860-HM86 Physical Dimensions (2-slot).....	23
1.9.2 TANK-860-HM86 Physical Dimensions (4-slot).....	24
1.9.3 TANK-860-HM86 Physical Dimensions (6-slot).....	25
2 UNPACKING	26
2.1 ANTI-STATIC PRECAUTIONS.....	27
2.2 UNPACKING PRECAUTIONS.....	27
2.3 UNPACKING CHECKLIST.....	28
3 INSTALLATION	31
3.1 INSTALLATION PRECAUTIONS.....	32
3.2 CFAST INSTALLATION.....	32
3.3 HARD DISK DRIVE (HDD) INSTALLATION.....	33
3.4 SYSTEM FAN INSTALLATION.....	36
3.5 MOUNTING THE SYSTEM WITH MOUNTING BRACKETS.....	37
3.6 EXTERNAL PERIPHERAL INTERFACE CONNECTORS.....	37
3.6.1 ACC Mode Selection.....	38
3.6.2 AT/ATX Power Mode Selection.....	39

3.6.3 Audio Connector	39
3.6.4 CFast Socket	40
3.6.5 Digital Input/Output Connector.....	40
3.6.6 DVI Connector.....	40
3.6.7 LAN Connectors.....	41
3.6.8 Power Input, 3-pin Terminal Block.....	43
3.6.9 Power Input, 4-pin DIN Connector	43
3.6.10 RJ-45 RS-232 Serial Ports.....	43
3.6.11 DB-9 RS-232/422/485 Serial Port Connectors	44
3.6.12 USB Connectors.....	45
3.6.13 VGA Connector	46
3.7 POWERING ON/OFF THE SYSTEM	47
3.8 POWER.....	48
3.8.1 ACC ON Mode	49
3.8.2 ACC OFF Mode.....	50
4 SYSTEM MOTHERBOARD.....	51
4.1 OVERVIEW.....	52
4.1.1 Layout	52
4.2 INTERNAL PERIPHERAL CONNECTORS.....	53
4.2.1 Backplane +12V Power Connector (BP_PWR1).....	53
4.2.2 Battery Connector (BAT1)	54
4.2.3 BIOS Programming Connector (SPI1).....	54
4.2.4 CFast Card connector (CFAST1)	54
4.2.5 CPU Fan Connector (CPU_FAN1).....	54
4.2.6 EC Debug Connector (LPT_DB1).....	55
4.2.7 EC Programming Connector (JSPI1).....	55
4.2.8 LED Connector (J2).....	55
4.2.9 SATA 3Gb/s Drive Connectors (SATA2).....	56
4.2.10 SATA Power Connectors (CN2, CN3).....	56
4.2.11 TPM Connector (TPM1)	56
4.3 EXTERNAL INTERFACE PANEL CONNECTORS.....	57
4.3.1 Audio Jack (JAUDIO1).....	57
4.3.2 DIO connector (DIO1).....	58
4.3.3 DisplayPort connector (DISPLAY_PORT1).....	58

4.3.4 DVI Connector (DVI_1).....	58
4.3.5 Ethernet and USB3.0 Connectors (LAN1_USB1).....	59
4.3.6 Ethernet and USB3.0 Connectors (LAN2_USB2).....	59
4.3.7 Power Connector (PWR1)	60
4.3.8 Power Connector (PWR2)	60
4.3.9 RS-232 Serial Port Connector (COM1_2).....	61
4.3.10 RS-232/422/485 Serial Port Connector (COM3_4)	61
4.3.11 RS-232 Serial Port Connectors (LANCOM1).....	61
4.3.12 USB 2.0 Connectors (USB1).....	62
4.3.13 VGA Connector (VGA1).....	62
5 BIOS	63
5.1 INTRODUCTION	64
5.1.1 Starting Setup.....	64
5.1.2 Using Setup	64
5.1.3 Getting Help.....	65
5.1.4 Unable to Reboot after Configuration Changes	65
5.1.5 BIOS Menu Bar.....	65
5.2 MAIN	67
5.3 ADVANCED.....	68
5.3.1 ACPI Settings	69
5.3.2 RTC Wake Settings	70
5.3.3 Trusted Computing.....	71
5.3.4 CPU Configuration.....	72
5.3.5 SATA Configuration	76
5.3.6 Intel(R) Rapid Start Technology.....	76
5.3.7 USB Configuration.....	78
5.3.8 F81866 Super IO Configuration	79
5.3.8.1 Serial Port n Configuration	80
5.3.9 F81866 H/W Monitor.....	85
5.3.9.1 Smart Fan Mode Configuration.....	85
5.3.10 Serial Port Console Redirection	88
5.3.10.1 Console Redirection Settings	90
5.3.11 iEi Feature.....	92
5.4 CHIPSET.....	93

TANK-860-HM86 Embedded System

5.4.1 PCH-IO Configuration	94
5.4.1.1 PCI Express Configuration.....	95
5.4.1.2 PCH Azalia Configuration.....	96
5.4.2 System Agent (SA) Configuration	96
5.4.2.1 Graphics Configuration.....	97
5.4.2.2 NB PCIe Configuration.....	99
5.4.2.3 Memory Configuration.....	100
5.5 BOOT.....	101
5.6 SECURITY.....	102
5.7 EXIT.....	104
A REGULATORY COMPLIANCE.....	106
B SAFETY PRECAUTIONS.....	111
B.1 SAFETY PRECAUTIONS.....	112
B.1.1 General Safety Precautions	112
B.1.2 Anti-static Precautions	113
B.1.3 Product Disposal	114
B.2 MAINTENANCE AND CLEANING PRECAUTIONS.....	114
B.2.1 Maintenance and Cleaning.....	114
B.2.2 Cleaning Tools.....	115
C DIGITAL I/O INTERFACE.....	116
C.1 INTRODUCTION.....	117
C.2 ASSEMBLY LANGUAGE SAMPLE 1	118
C.3 ASSEMBLY LANGUAGE SAMPLE 2	118
D HAZARDOUS MATERIALS DISCLOSURE	119
D.1 HAZARDOUS MATERIALS DISCLOSURE TABLE FOR IPB PRODUCTS CERTIFIED AS ROHS COMPLIANT UNDER 2002/95/EC WITHOUT MERCURY.....	120

List of Figures

Figure 1-1: TANK-860-HM86 Series	2
Figure 1-2: TANK-860-HM86 Series Front Panel	6
Figure 1-3: TANK-860-HM86 Series Front Panel	8
Figure 1-4: TANK-860-HM86 Series Front Panel	10
Figure 1-5: TANK-860-HM86 Series Rear Panel.....	11
Figure 1-6: TANK-860-HM86 Series LED Indicators.....	12
Figure 1-7: HPE-2S86 (for 2-slot model).....	14
Figure 1-8: HPE-4S86 (for 4-slot model).....	14
Figure 1-9: HPE-6S86 (for 6-slot model).....	17
Figure 1-10: Backplane Power	22
Figure 1-11: 2-slot TANK-860-HM86 Physical Dimensions (millimeters).....	23
Figure 1-12: 4-slot TANK-860-HM86 Physical Dimensions (millimeters).....	24
Figure 1-13: 6-slot TANK-860-HM86 Physical Dimensions (millimeters).....	25
Figure 3-1: CFast Socket	33
Figure 3-2: CFast Socket Cover	33
Figure 3-3: Unscrew the Cover.....	34
Figure 3-4: Remove the Cover from TANK-860-HM86 Series	34
Figure 3-5: HDD Installation	35
Figure 3-6: HDD Retention Screws	35
Figure 3-7: System Fan Installation	36
Figure 3-8: Mounting Bracket Retention Screws	37
Figure 3-9: ACC Mode Switch	38
Figure 3-10: AT/ATX Power Mode Switch	39
Figure 3-11: Audio Connector	39
Figure 3-12: DIO Connector.....	40
Figure 3-13: DVI Connector	41
Figure 3-14: LAN Connection	42
Figure 3-15: RJ-45 Ethernet Connector.....	42
Figure 3-16: 3-pin Terminal Block.....	43
Figure 3-17: Power Input Connector.....	43

TANK-860-HM86 Embedded System

Figure 3-18: RJ-45 RS-232 Serial Device Connection	44
Figure 3-19: RJ-45 RS-232 Serial Port Connector	44
Figure 3-20: Serial Device Connector	45
Figure 3-21: DB-9 RS-232/422/485 Serial Port Connector	45
Figure 3-22: USB Device Connection	46
Figure 3-23: VGA Connector	47
Figure 3-24: VGA Connector	47
Figure 3-25: Power Button	48
Figure 3-26: Power Connectors	49
Figure 4-1: System Motherboard (Front)	52
Figure 4-2: System Motherboard (Rear)	52

List of Tables

Table 1-1: TANK-860-HM86 Series Model Variations	3
Table 1-2: Technical Specifications	6
Table 1-3: LED Indicators Description	12
Table 1-4: Supported Signals	20
Table 1-5: Rated Voltage and Current	20
Table 1-6: Rated Voltage and Current	20
Table 1-7: Rated Voltage and Current	21
Table 3-1: RJ-45 Ethernet Connector LEDs	42
Table 3-2: Power LED Indicators Description	49
Table 4-1: Peripheral Interface Connectors	53
Table 4-2: Backplane +12V Power Connector Pinouts (BP_PWR1)	53
Table 4-3: Battery Connector Pinouts (BAT1)	54
Table 4-4: BIOS Programming Connector Pinouts (SPI1)	54
Table 4-5: CFast Card Connector Pinouts (CFAST1)	54
Table 4-6: CPU Fan Connector Pinouts (CPU_FAN1)	54
Table 4-7: EC Debug Connector Pinouts (LPT_DB1)	55
Table 4-8: EC Programming Connector Pinouts (JSPI1)	55
Table 4-9: LED Connector Pinouts (J2)	55
Table 4-11: SATA 3Gb/s Drive Connectors Pinouts (SATA2)	56
Table 4-12: SATA Power Connectors Pinouts (CN2, CN3)	56
Table 4-13: TPM Connector Pinouts (TPM1)	56
Table 4-14: Rear Panel Connectors	57
Table 4-15: Audio Jack Pinouts (AUDIO1)	57
Table 4-16: DIO connector Pinouts (DIO1)	58
Table 4-17: DisplayPort connector Pinouts (DISPLAY_PORT1)	58
Table 4-18: DVI Connector Pinouts (DVI_I)	59
Table 4-19: USB 3.0 Port Pinouts (USB1)	59
Table 4-20: LAN Pinouts (LAN1)	59
Table 4-21: USB 3.0 Port Pinouts (USB2)	60
Table 4-22: LAN Pinouts (LAN2)	60

TANK-860-HM86 Embedded System

Table 4-23: Power Connector Pinouts (PWR2)	60
Table 4-24: Power Connector Pinouts (PWR1)	60
Table 4-25: RS-232 Serial Port Connector Pinouts (COM1)	61
Table 4-26: RS-232 Serial Port Connector Pinouts (COM2)	61
Table 4-27: RS-232/422/485 Serial Port Connector Pinouts (COM3_4)	61
Table 4-28: RS-232 Serial Port Connectors Pinouts (LANCOM1)	62
Table 4-29: USB 2.0 Connectors Pinouts (USB1)	62
Table 4-30: VGA Connector Pinouts (VGA1)	62
Table 5-1: BIOS Navigation Keys	65

Chapter

1

Introduction

1.1 Overview



Figure 1-1: TANK-860-HM86 Series

The TANK-860-HM86 Series is an embedded system for wide range temperature environments. It is powered by the 4th generation Intel® Core™ processor, uses the Intel® HM86 chipset and supports two 204-pin DDR3 SDRAM SO-DIMM modules up to 16 GB (4GB memory preinstalled). The TANK-860-HM86 Series includes one VGA port, one DVI-I port, one DisplayPort, two GbE LAN ports, four USB 3.0 ports, two USB 2.0 ports, four RS-232 connectors and two RS-232/422/485 connectors.

1.2 Model Variations

The model variations of the TANK-860-HM86 Series series are listed below.

Model No.	CPU	Expansion Slots
TANK-860-HM86i-i5/4G/2A-R10	Intel® Core™ i5-4400E 2.7 GHz dual-core	2 x PCIe expansion
TANK-860-HM86i-i5/4G/4A-R10		2 x PCIe and 2 x PCI expansion
TANK-860-HM86i-i5/4G/6A-R10		3 x PCIe and 3 x PCI expansion
TANK-860-HM86i-C/4G/2A-R10	Intel® Celeron® 2000E 2.2 GHz dual-core	2 x PCIe expansion
TANK-860-HM86i-C/4G/4A-R10		2 x PCIe and 2 x PCI expansion
TANK-860-HM86i-C/4G/6A-R10		3 x PCIe and 3 x PCI expansion

Table 1-1: TANK-860-HM86 Series Model Variations

1.3 Features

The TANK-860-HM86 Series features are listed below:

- Intel® HM86 chipset with 4th generation Intel® Core™ CPU
- Great flexibility of expansion slots
 - 2-slot model: 2 x PCIe x 16
 - 4-slot model: 2 x PCIe x 16 , 2 x PCI , 1 x PCIe mini slot
 - 6-slot model: 2 x PCIe x 16 , 1 x PCIe x 1 , 3 x PCI , 1 x PCIe mini slot
- IPMI function for remote control management
- Three independent video outputs support high resolution
- Dual 2.5" SATA HDD bay design fulfills high storage demand

1.4 Technical Specifications

The TANK-860-HM86 Series technical specifications are listed in **Table 1-2**.

Specifications	
Chassis	
Color	Black C + Silver
Dimensions (WxHxD) (mm)	2-slot: 121.5 x 255.2 x 205 4-slot: 154.8 x 255.2 x 205 6-slot: 195.4 x 255.2 x 205
System Fan	Fanless
Chassis Construction	Extruded aluminum alloys
Motherboard	
Processor CPU	Intel® Core™ i5-4400E 2.7 GHz Intel® Celeron® 2000E 2.2 GHz
Chipset	Intel® HM86
System Memory	2 x 204-pin DDR3 SO-DIMM 4 GB pre-installed (system max: 16 GB)
IPMI	
iRIS Solution	iRIS-2400
Storage	
Hard Drive	2 x 2.5" SATA 6Gb/s HDD/SSD bay
CFast	1 x CFast
mSATA	1 x mSATA (SATA 3Gb/s signal)
I/O Interfaces	
USB 3.0	4
USB 2.0	2
Ethernet	Two RJ-45: 1 x PCIe GbE by Intel® I210 1 x PCIe GbE by Intel® I217LM

TANK-860-HM86 Embedded System

Specifications	
RS-232	2 x DB-9 2 x RJ-45
RS-232/422/485	2 x DB-9
Digital I/O	8-bit digital I/O, 4-bit input/4-bit output
Display	1 x VGA, 1 x DVI-I, 1 x DisplayPort
Resolution	VGA: Up to 1920 x 1200@60Hz DVI-I: Up to 2500 x 1600@60Hz DisplayPort: Up to 2500 x 1600@60Hz
Audio	1 x Line-out, 1 x Mic-in
Wireless	802.11b/g/n 1T1R (optional)
Expansions	
PCI/PCIe	2 A: Two PCIe x8 (physical PCIe x16 slot) 4 A: Two PCIe x8 (physical PCIe x16 slot) + 2 x PCI 6 A: One PCIe x8 (physical PCIe x16 slot) + 2 x PCIe by 4 + 3 x PCI
PCIe Mini	1 x Full Size (Co-lay mSATA)
Reliability	
Mounting	Wall mount
Operating Temperature	-20°C ~ 70°C with air flow (SSD), 5% ~ 95%, non-condensing
Operating Shock	Half-sine wave shock 5G, 11ms, 3 shocks per axis
Operating Vibration	MIL-STD-810F 514.5C-2 (with SSD)
Weight (Net/Gross)	2-slot: 4.2 kg/6.3 kg 4-slot: 4.5 kg/6.5 kg 6-slot: 4.8 kg/6.9 kg
Safety/EMC	CE/FCC

Specifications	
OS	
Supported OS	Microsoft® Windows® 8 Embedded, Microsoft® Windows® Embedded Standard 7 E

Table 1-2: Technical Specifications

1.5 Front Panel

1.5.1 TANK-860-HM86-2 slot Front Panel

The front panel of the TANK-860-HM86 Series has the following features (**Figure 1-2**):

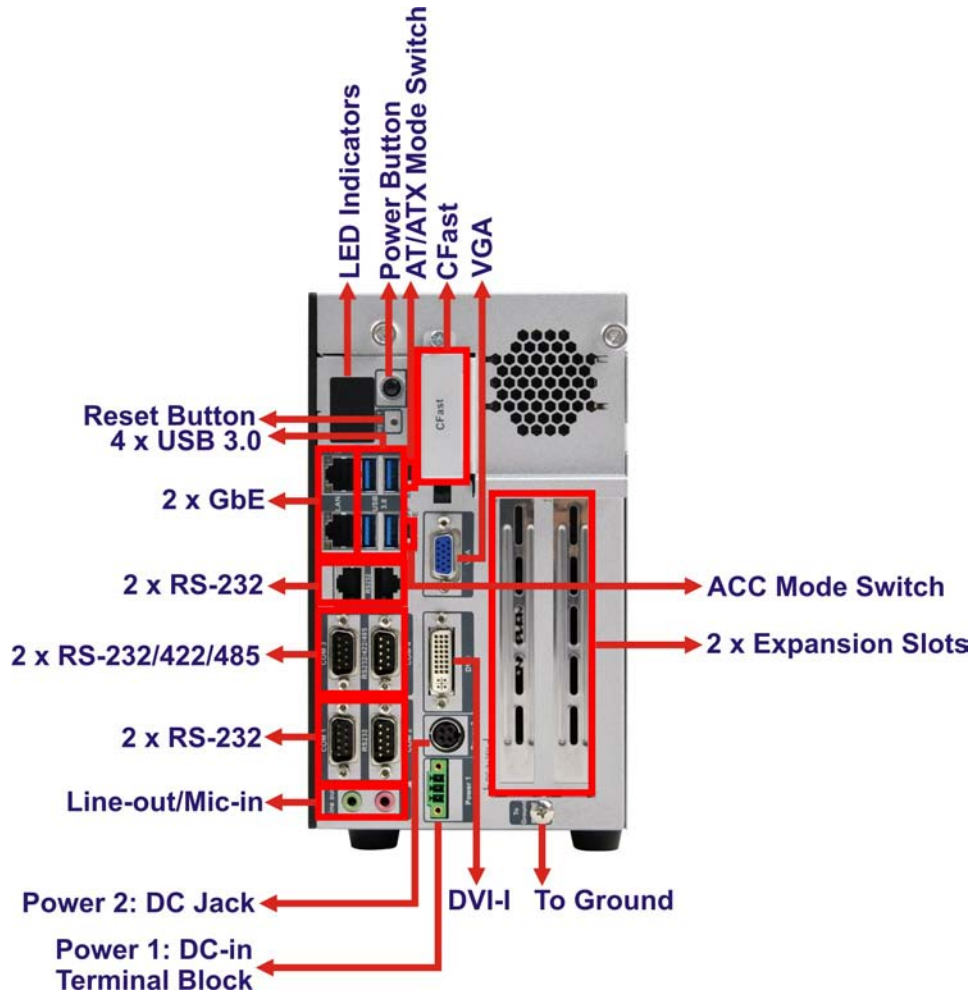

Figure 1-2: TANK-860-HM86 Series Front Panel

TANK-860-HM86 Embedded System

Connectors and buttons on the front panel include the following:

- 1 x 4-pin power DC jack for 9 V ~ 36 V power input
- 1 x Power terminal block for 9 V ~ 36 V power input
- 1 x Mic-in port (pink)
- 1 x Line-out port (green)
- 2 x RS-232 serial ports (DB-9)
- 2 x RS-232 serial ports (RJ-45)
- 2 x RS-232/422/485 serial ports (DB-9)
- 2 x Gigabit Ethernet ports (RJ-45)
- 4 x USB 3.0 ports
- 1 x Reset button
- 6 x LED indicators (**Section 1.7**)
- 1 x Power button
- 1 x CFast
- 1 x VGA port
- 1 X DVI-I port
- 1 x To Ground
- 2 x Expansion slots
- 1 x ACC mode switch
- 1 x AT/ATX mode switch

1.5.2 TANK-860-HM86-4 slot Front Panel

The front panel of the TANK-860-HM86 Series has the following features (**Figure 1-2**):

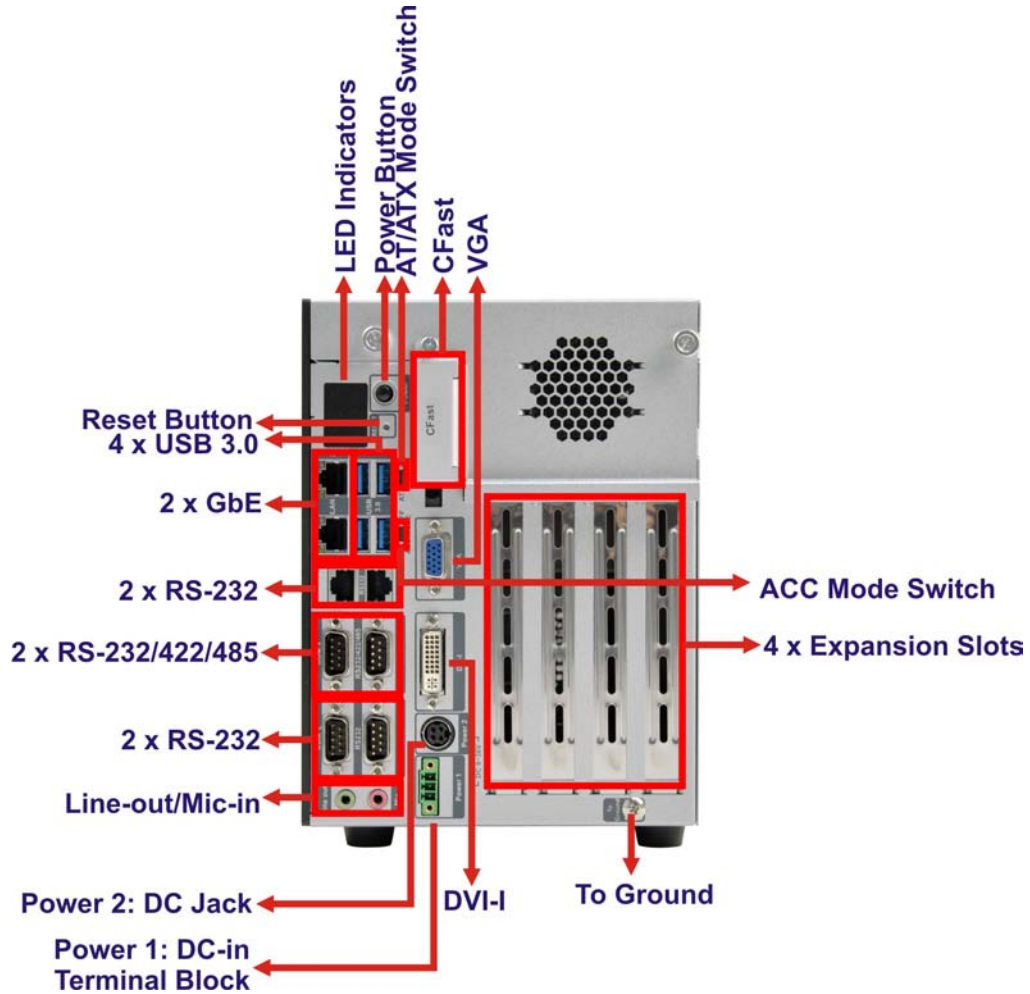

Figure 1-3: TANK-860-HM86 Series Front Panel

Connectors and buttons on the front panel include the following:

- 1 x 4-pin power DC jack for 9 V ~ 36 V power input
- 1 x Power terminal block for 9 V ~ 36 V power input
- 1 x Mic-in port (pink)
- 1 x Line-out port (green)
- 2 x RS-232 serial ports (DB-9)
- 2 x RS-232 serial ports (RJ-45)
- 2 x RS-232/422/485 serial ports (DB-9)

TANK-860-HM86 Embedded System

- 2 x Gigabit Ethernet ports (RJ-45)
- 4 x USB 3.0 ports
- 1 x Reset button
- 6 x LED indicators (**Section 1.7**)
- 1 x Power button
- 1 x CFast
- 1 x VGA port
- 1 X DVI-I port
- 1 x To Ground
- 4 x Expansion slots
- 1 x ACC mode switch
- 1 x AT/ATX mode switch

1.5.3 TANK-860-HM86-6 slot Front Panel

The front panel of the TANK-860-HM86 Series has the following features (**Figure 1-2**):

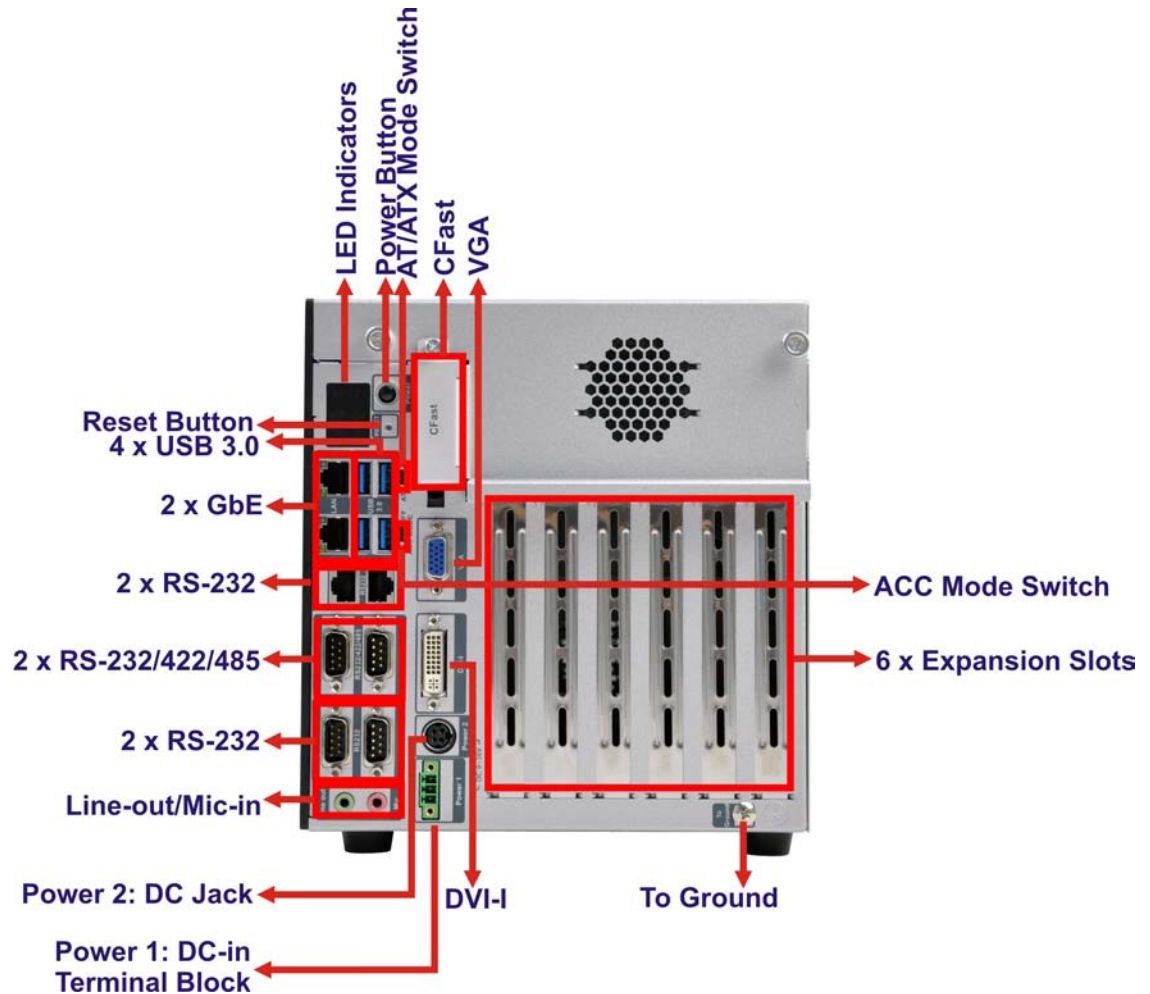

Figure 1-4: TANK-860-HM86 Series Front Panel

Connectors and buttons on the front panel include the following:

- 1 x 4-pin power DC jack for 9 V ~ 36 V power input
- 1 x Power terminal block for 9 V ~ 36 V power input
- 1 x Mic-in port (pink)
- 1 x Line-out port (green)
- 2 x RS-232 serial ports (DB-9)
- 2 x RS-232 serial ports (RJ-45)
- 2 x RS-232/422/485 serial ports (DB-9)

TANK-860-HM86 Embedded System

- 2 x Gigabit Ethernet ports (RJ-45)
- 4 x USB 3.0 ports
- 1 x Reset button
- 6 x LED indicators (**Section 1.7**)
- 1 x Power button
- 1 x CFast
- 1 x VGA port
- 1 X DVI-I port
- 1 x To Ground
- 6 x Expansion slots
- 1 x ACC mode switch
- 1 x AT/ATX mode switch

1.6 Rear Panel

The rear panel of the TANK-860-HM86 Series has the following features (**Figure 1-2**):

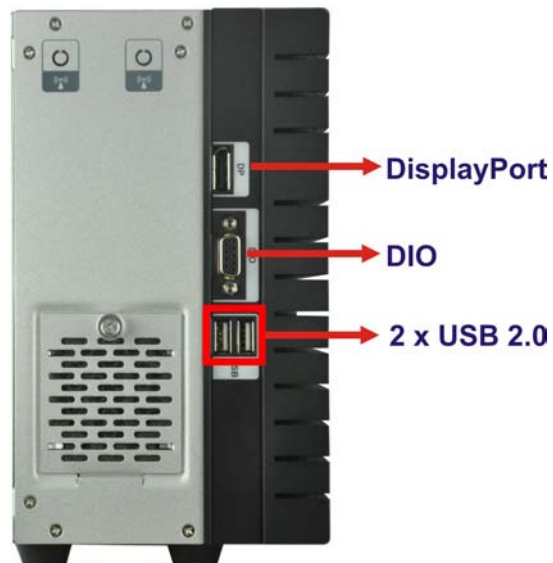

Figure 1-5: TANK-860-HM86 Series Rear Panel

Connectors on the front panel include the following:

- 1 x DisplayPort connector
- 1 x DIO connector

- 2 x USB 2.0 ports

1.7 LED Indicators

There are several indicators on the rear panel of the TANK-860-HM86 Series as shown in **Figure 1-6**.

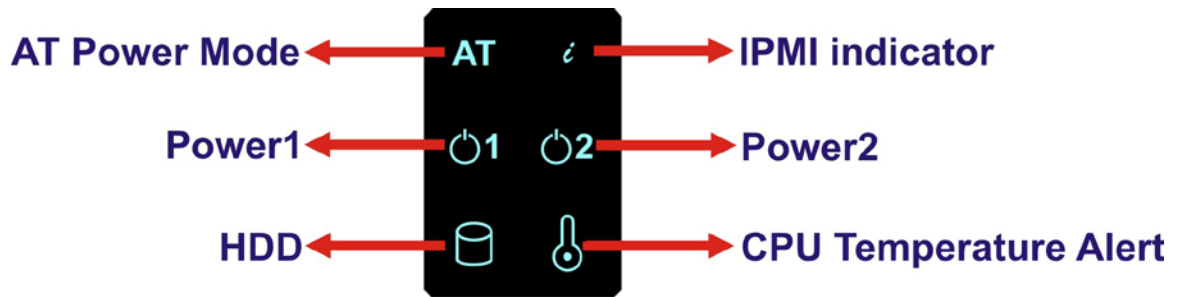

Figure 1-6: TANK-860-HM86 Series LED Indicators

The descriptions of each LED indicator are listed below.

LED Indicator	Description
AT Power Mode	The current power mode status is AT mode. Controlled by the AT/ATX power mode switch.
i	Shows IPMI status.
Power LED1	Breathing Orange: Standby mode.
Power LED2	Solid blue: Power-on mode.
HDD	Shows HDD status.
CPU Temperature Alert	BLUE: CPU temperature is normal. RED: CPU temperature is too high.

Table 1-3: LED Indicators Description

**WARNING:**

The CPU Temperature Alert LED turns red when the CPU temperature is too high. If this situation occurs, lower the environment temperature or close some running applications to cool down the CPU.

1.8 Backplane Options

The backplane options of the TANK-860-HM86 Series are shown below.

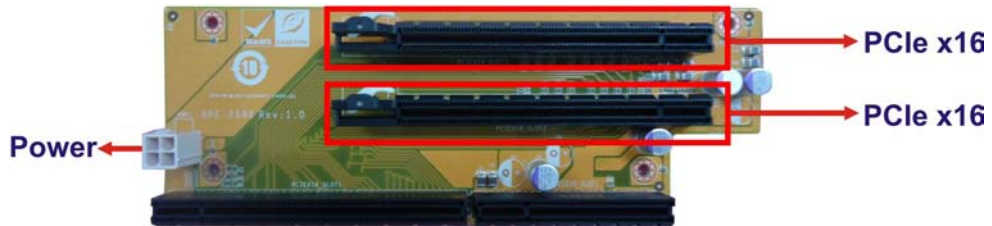
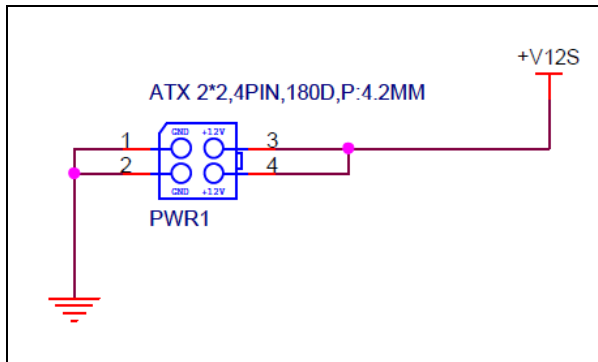

Figure 1-7: HPE-2S86 (for 2-slot model)

PWR1:



Pin	Description
1	GND
2	GND
3	+12 V
4	+12 V

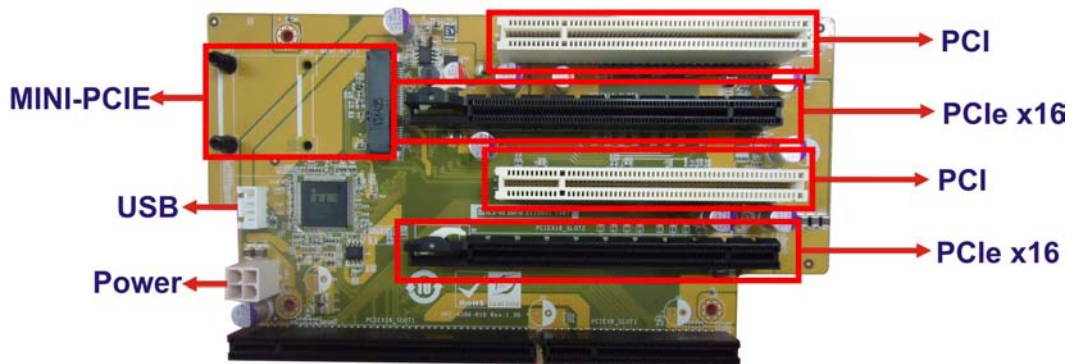
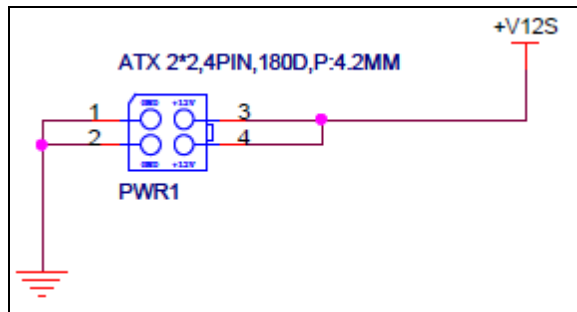

Figure 1-8: HPE-4S86 (for 4-slot model)

TANK-860-HM86 Embedded System

PWR1:



Pin	Description
1	GND
2	GND
3	+12 V
4	+12 V

USB1:

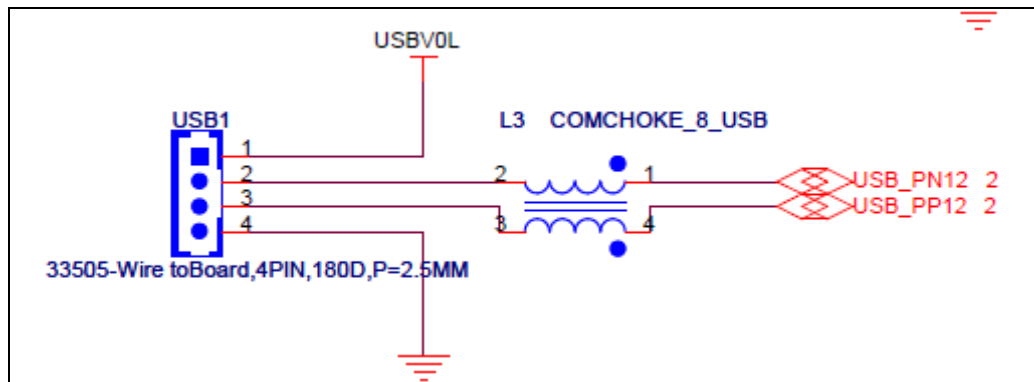

Pin	Description
1	VCC
2	Data-
3	Data+
4	GND

MINI-PCIE1:

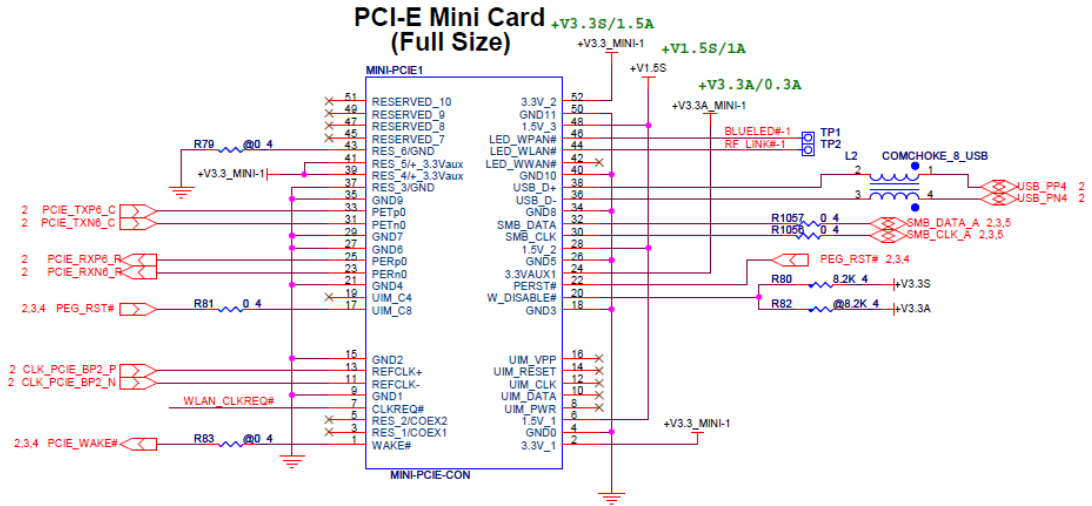

Pin	Description	Pin	Description
1	PCIE_WAKE#	2	VCC3
3	N/C	4	GND
5	N/C	6	1.5 V
7	WLAN_CLKREQ#	8	N/C
9	GND	10	N/C
11	CLK-	12	N/C
13	CLK+	14	N/C
15	GND	16	N/C
17	PCIRST#	18	GND
19	N/C	20	VCC3
21	GND	22	PCIRST#
23	PCIE-RXN	24	VCC3
25	PCIE-RXP	26	GND
27	GND	28	1.5 V
29	GND	30	SMBCLK
31	PCIE-TXN	32	SMBDATA
33	PCIE-TXP	34	GND
35	GND	36	USB D-
37	GND	38	USB D+
39	VCC3	40	GND

TANK-860-HM86 Embedded System

Pin	Description	Pin	Description
41	VCC3	42	N/C
43	GND	44	RF_LINK#
45	N/C	46	BLUELED#
47	N/C	48	1.5 V
49	N/C	50	GND
51	N/C	52	VCC3

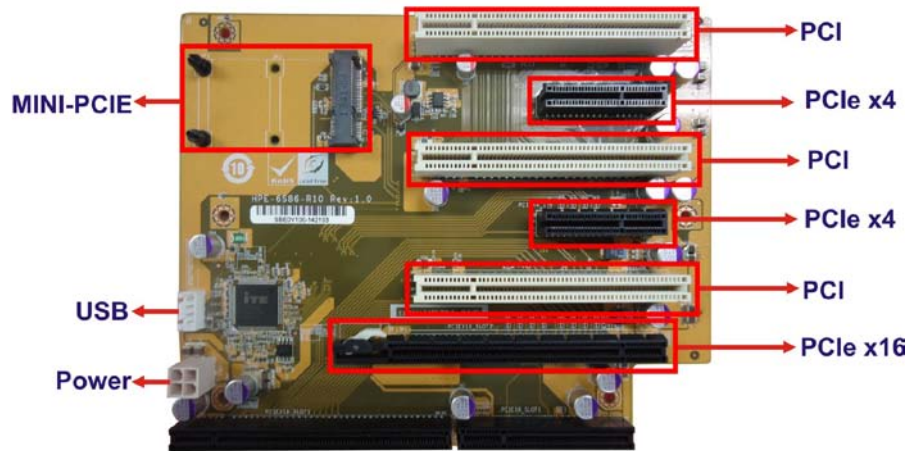
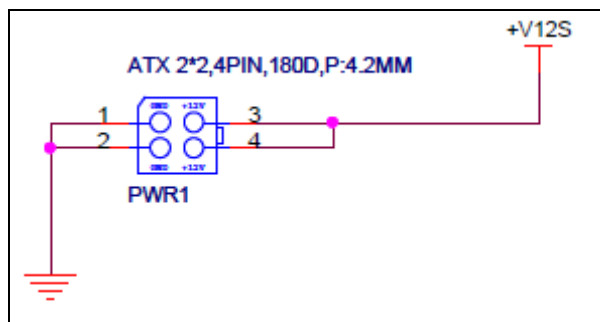

Figure 1-9: HPE-6S86 (for 6-slot model)

PWR1:



Pin	Description
1	GND
2	GND
3	+12 V
4	+12 V

USB1:

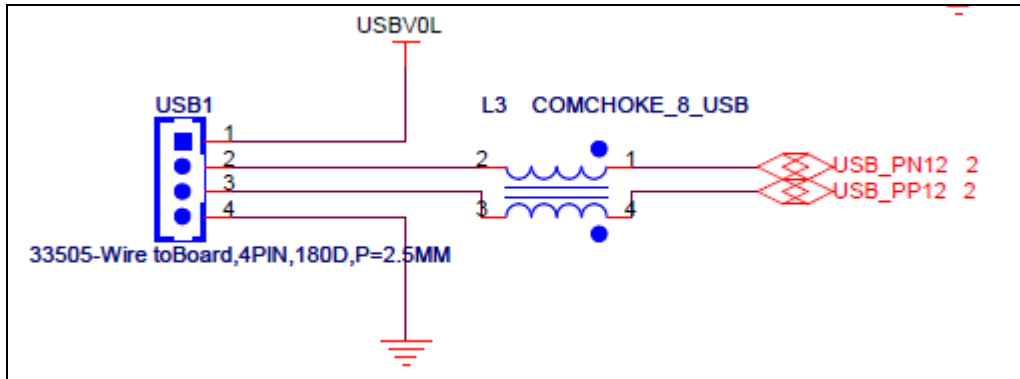

Pin	Description
1	VCC
2	Data-
3	Data+
4	GND

MINI-PCIE1:

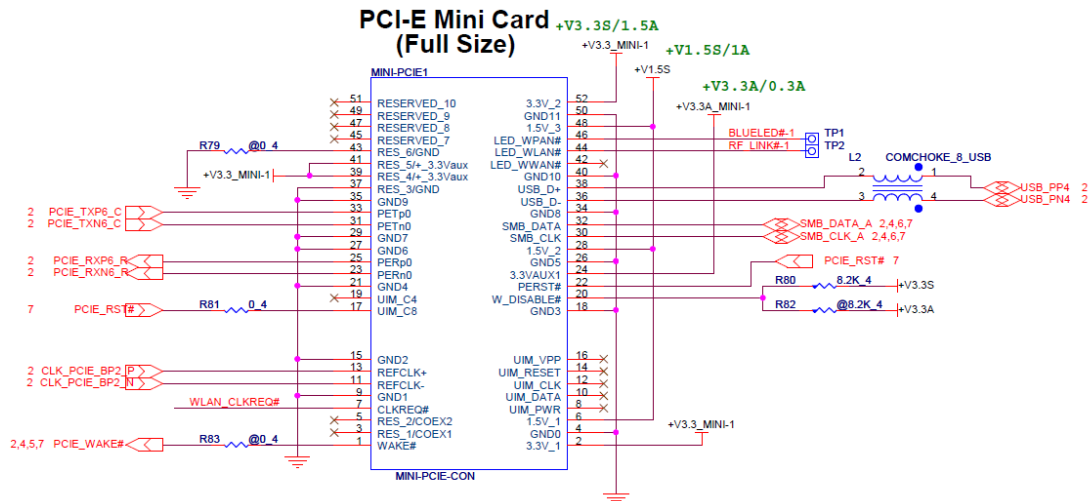

Pin	Description	Pin	Description
1	PCIE_WAKE#	2	VCC3
3	N/C	4	GND
5	N/C	6	1.5 V
7	WLAN_CLKREQ#	8	N/C
9	GND	10	N/C

TANK-860-HM86 Embedded System

Pin	Description	Pin	Description
11	CLK-	12	N/C
13	CLK+	14	N/C
15	GND	16	N/C
17	PCIRST#	18	GND
19	N/C	20	VCC3
21	GND	22	PCIRST#
23	PCIE-RXN	24	VCC3
25	PCIE-RXP	26	GND
27	GND	28	1.5 V
29	GND	30	SMBCLK
31	PCIE-TXN	32	SMBDATA
33	PCIE-TXP	34	GND
35	GND	36	USBD-
37	GND	38	USBD+
39	VCC3	40	GND
41	VCC3	42	N/C
43	GND	44	RF_LINK#
45	N/C	46	BLUELED#
47	N/C	48	1.5 V
49	N/C	50	GND
51	N/C	52	VCC3

The supported signals of the backplane slots are listed below.

Backplane	Slot	Signal
2-slot model	PCIe x16	PCIe x8
	PCIe x16	PCIe x8
4-slot model	PCIe x16	PCIe x8
	PCIe x16	PCIe x8
	PCI	PCI
	PCI	PCI
6-slot model	PCIe x16	PCIe x8
	PCIe x4	PCIe x4

Backplane	Slot	Signal
	PCIe x4	PCIe x4
	PCI	PCI
	PCI	PCI
	PCI	PCI

Table 1-4: Supported Signals

The rated voltage and current of the backplanes are listed below.

120W/19V adaptor backplane total power limit:30W

Rated Voltage	Rated Current
+5 V	4.0 A
+12 V	2.5 A
-12 V	0.1 A
+3.3 V	5.0 A

Table 1-5: Rated Voltage and Current

150W/12V adaptor backplane total power limit:50W

Rated Voltage	Rated Current
+5 V	4.0 A
+12 V	4.0A
-12 V	0.1 A
+3.3 V	5.0 A

Table 1-6: Rated Voltage and Current

180W/19V adaptor backplane total power limit:70W

Rated Voltage	Rated Current
+5 V	4.0 A
+12 V	5.5 A

TANK-860-HM86 Embedded System

-12 V	0.1 A
+3.3 V	5.0 A

Table 1-7: Rated Voltage and Current**WARNING:**

1. The system power consumption is 80W w/o add-on card.
2. The maximum total power of the backplane to support expansion cards is different based on different adapter.
3. Please check your add-on card total consumption to choose suitable power adapter.

**NOTE:**

When using an expansion card with high power consumption, it is recommended to install an external power supply to the 12V power input connector on the backplane.

The three types of backplane support standard PCI/PCIe cards with maximum dimensions (WxL):110 x 230 mm.

The figure below shows how to connect an external power supply to the 12V power input connector on the backplane.

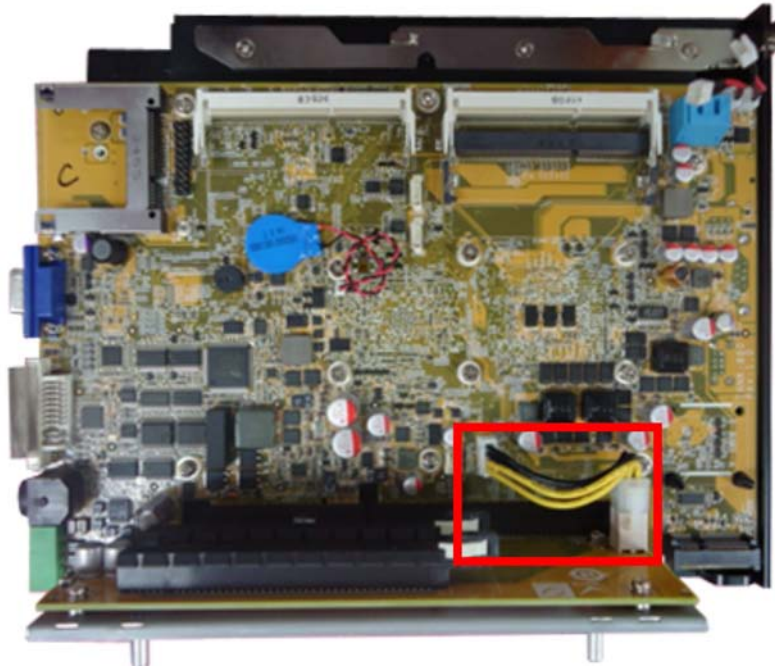

Figure 1-10: Backplane Power

TANK-860-HM86 Embedded System

1.9 Physical Dimensions

The following sections describe the physical dimensions for each model of the TANK-860-HM86 Series.

1.9.1 TANK-860-HM86 Physical Dimensions (2-slot)

The physical dimensions of the 2-slot TANK-860-HM86 are shown in **Figure 1-10**.

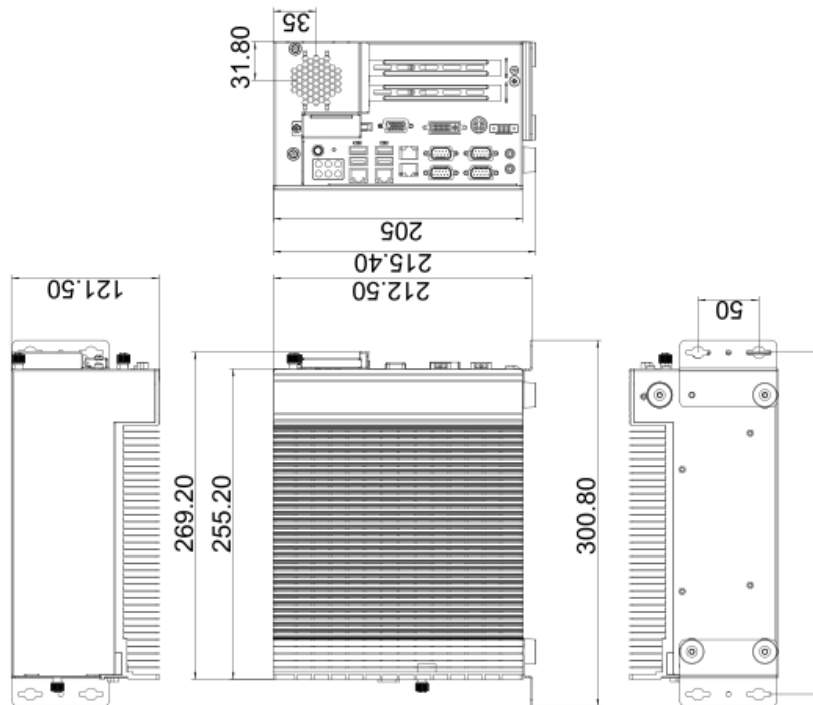

Figure 1-11: 2-slot TANK-860-HM86 Physical Dimensions (millimeters)

1.9.2 TANK-860-HM86 Physical Dimensions (4-slot)

The physical dimensions of the 4-slot TANK-860-HM86 are shown in **Figure 1-12**.

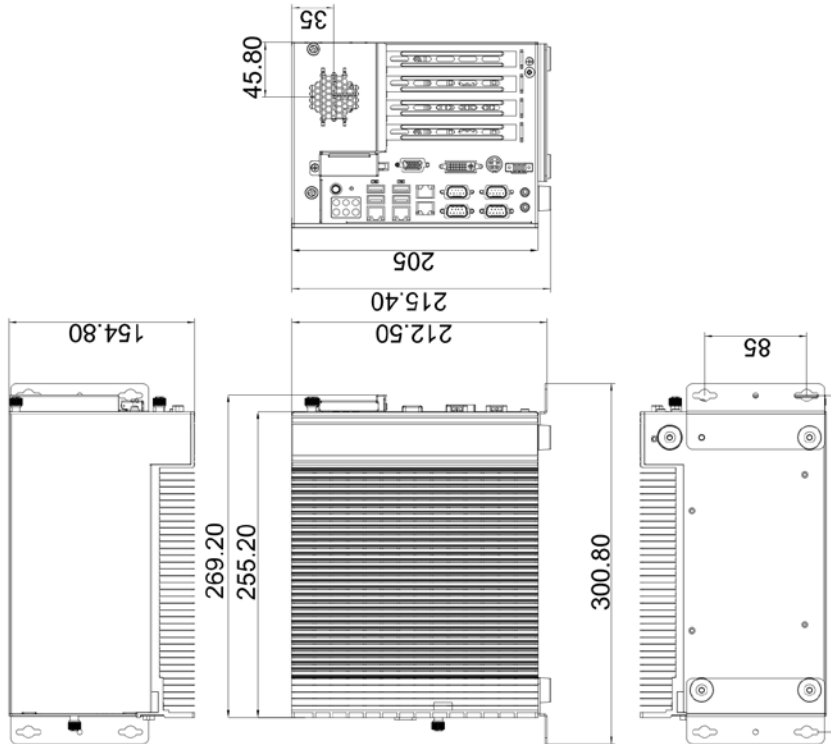

Figure 1-12: 4-slot TANK-860-HM86 Physical Dimensions (millimeters)

TANK-860-HM86 Embedded System

1.9.3 TANK-860-HM86 Physical Dimensions (6-slot)

The physical dimensions of the 6-slot TANK-860-HM86 are shown in **Figure 1-13**.

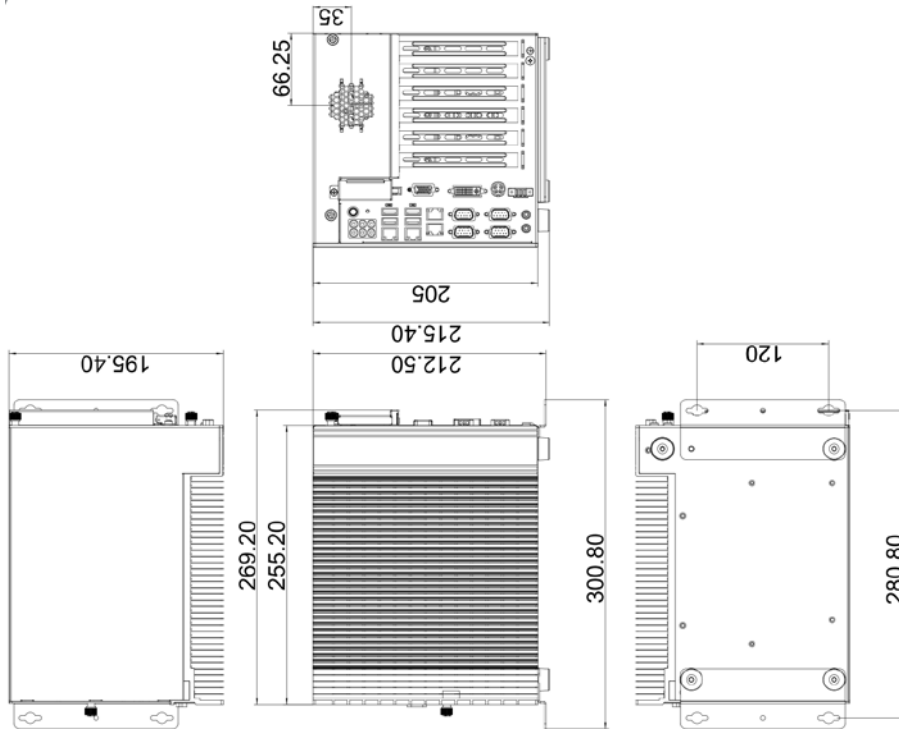

Figure 1-13: 6-slot TANK-860-HM86 Physical Dimensions (millimeters)

Chapter

2

Unpacking

2.1 Anti-static Precautions



WARNING:

Failure to take ESD precautions during installation may result in permanent damage to the TANK-860-HM86 Series and severe injury to the user.

Electrostatic discharge (ESD) can cause serious damage to electronic components, including the TANK-860-HM86 Series. Dry climates are especially susceptible to ESD. It is therefore critical that whenever the TANK-860-HM86 Series or any other electrical component is handled, the following anti-static precautions are strictly adhered to.

- ***Wear an anti-static wristband:*** Wearing a simple anti-static wristband can help to prevent ESD from damaging the board.
- ***Self-grounding:*** Before handling the board touch any grounded conducting material. During the time the board is handled, frequently touch any conducting materials that are connected to the ground.
- ***Use an anti-static pad:*** When configuring the TANK-860-HM86 Series, place it on an anti-static pad. This reduces the possibility of ESD damaging the TANK-860-HM86 Series.

2.2 Unpacking Precautions

When the TANK-860-HM86 Series is unpacked, please do the following:

- Follow the anti-static precautions outlined in **Section 2.1**.
- Make sure the packing box is facing upwards so the TANK-860-HM86 Series does not fall out of the box.
- Make sure all the components shown in **Section 2.3** are present.





2.3 Unpacking Checklist



NOTE:

If some of the components listed in the checklist below are missing, please do not proceed with the installation. Contact the IEI reseller or vendor you purchased the TANK-860-HM86 Series from or contact an IEI sales representative directly. To contact an IEI sales representative, please send an email to sales@ieiworld.com.



The TANK-860-HM86 Series is shipped with the following components:

Quantity	Item and Part Number	Image
Standard		
1	TANK-860-HM86 Series	
2	Mounting Brackets	
1	One Key Recovery CD (P/N: 7B000-000724-RS)	
1	User Manual and Driver CD	

TANK-860-HM86 Embedded System

The following table lists the optional items that can be purchased separately.

Optional	
System Fan (P/N: 19FFD124015LB-000001-RS)	
Power Adapter (120W) (P/N: 63000-FSP120AAB-RS)	
Power Cord	
EUROPEAN CODE(VDE) (P/N: 32000-089900-RS)	
AMERICA CODE (UL) (P/N: 32701-000500-200-RS)	
JAPAN CODE(PSE) (P/N: 32000-106700-RS)	
AUSTRALIAN CODE(SAA) (P/N: 32704-000300-100-RS)	
Power Adapter (150W) (P/N: 63000-FSP150AHAN1808-RS)	
Power Cord	
EUROPEAN CODE(VDE) (P/N: 32000-000002-RS)	

Optional	
AMERICA CODE (UL) (P/N: 32000-000025-RS)	
JAPAN CODE(PSE) (P/N: 32706-000100-100-RS)	
AUSTRALIAN CODE(SAA) (P/N: 32000-000022-RS)	
<p>Note: It is suggested to use the 90 W adapter for applications without add-on cards. For applications with add-on cards, please choose an adapter based on the power consumption of the TANK-860 (65 W) plus that of the add-on card.</p>	

Chapter

3

Installation

3.1 Installation Precautions

During installation, be aware of the precautions below:

- **Read the user manual:** The user manual provides a complete description of the TANK-860-HM86 Series, installation instructions and configuration options.
- **DANGER! Disconnect Power:** Power to the TANK-860-HM86 Series must be disconnected during the installation process, or before any attempt is made to access the rear panel. Electric shock and personal injury might occur if the rear panel of the TANK-860-HM86 Series is opened while the power cord is still connected to an electrical outlet.
- **Qualified Personnel:** The TANK-860-HM86 Series must be installed and operated only by trained and qualified personnel. Maintenance, upgrades, or repairs may only be carried out by qualified personnel who are familiar with the associated dangers.
- **Air Circulation:** Make sure there is sufficient air circulation when installing the TANK-860-HM86 Series. The TANK-860-HM86 Series's cooling vents must not be obstructed by any objects. Blocking the vents can cause overheating of the TANK-860-HM86 Series. Leave at least 5 cm of clearance around the TANK-860-HM86 Series to prevent overheating.
- **Grounding:** The TANK-860-HM86 Series should be properly grounded. The voltage feeds must not be overloaded. Adjust the cabling and provide external overcharge protection per the electrical values indicated on the label attached to the back of the TANK-860-HM86 Series.

3.2 CFast Installation

To install the CFast card, please follow the steps below:

Step 1: Locate the CFast socket, and then loosen the thumbscrew (**Figure 3-1**).

TANK-860-HM86 Embedded System



Figure 3-1: CFast Socket

Step 2: Open the CFast socket cover (Figure 3-2).

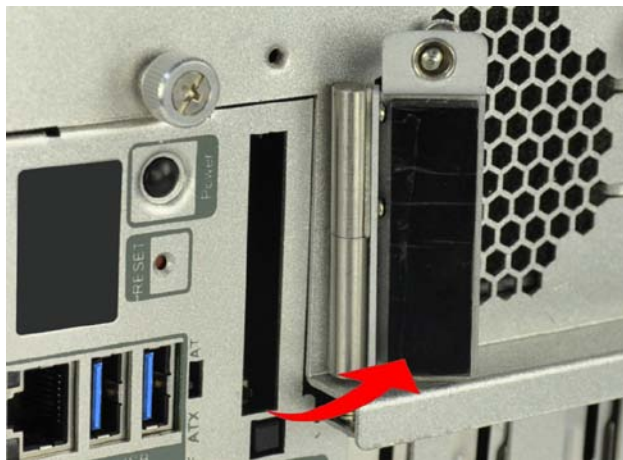

Figure 3-2: CFast Socket Cover

Step 3: Correctly align the CFast card with the socket and insert the CFast card into the socket.

Step 4: Reinstall the cover.

3.3 Hard Disk Drive (HDD) Installation

To install the hard drive, please follow the steps below:

Step 1: Remove the two retention screws on the rear panel and loosen the two thumbscrews on the front panel, slide the cover outward, and then lift the cover up gently (**Figure 3-3**).



Figure 3-3: Unscrew the Cover

Step 2: Unplug the SATA signal and power cables connected to the TANK-860-HM86 Series, and then put the cover on a flat surface (**Figure 3-4**).

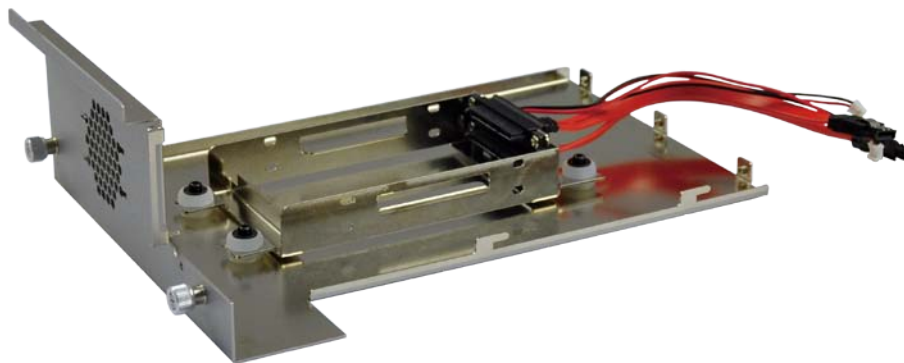

Figure 3-4: Remove the Cover from TANK-860-HM86 Series

Step 3: Attach the HDD to the HDD bracket, and then slide the HDD to connect with the SATA connector (**Figure 3-5**).

TANK-860-HM86 Embedded System

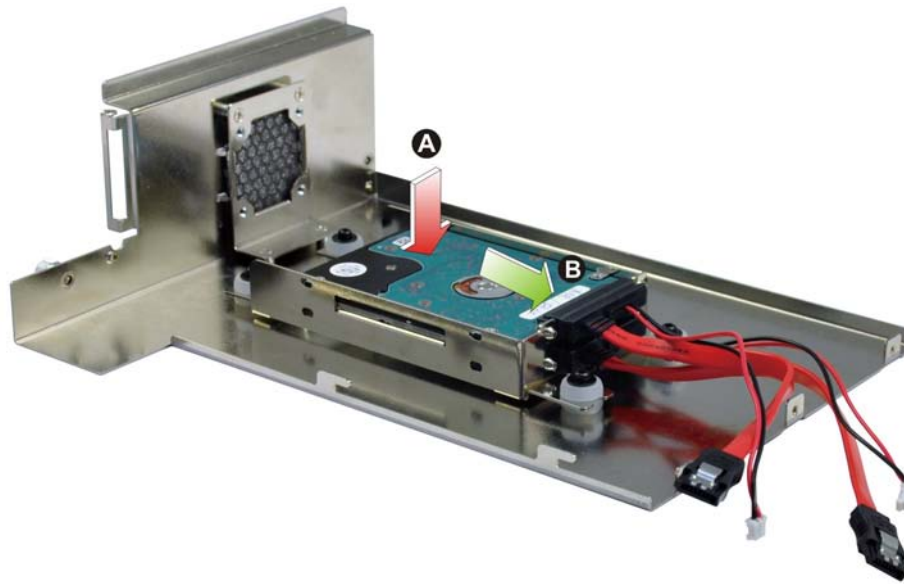

Figure 3-5: HDD Installation

Step 4: Secure the HDD with the HDD bracket by four retention screws (**Figure 3-6**).

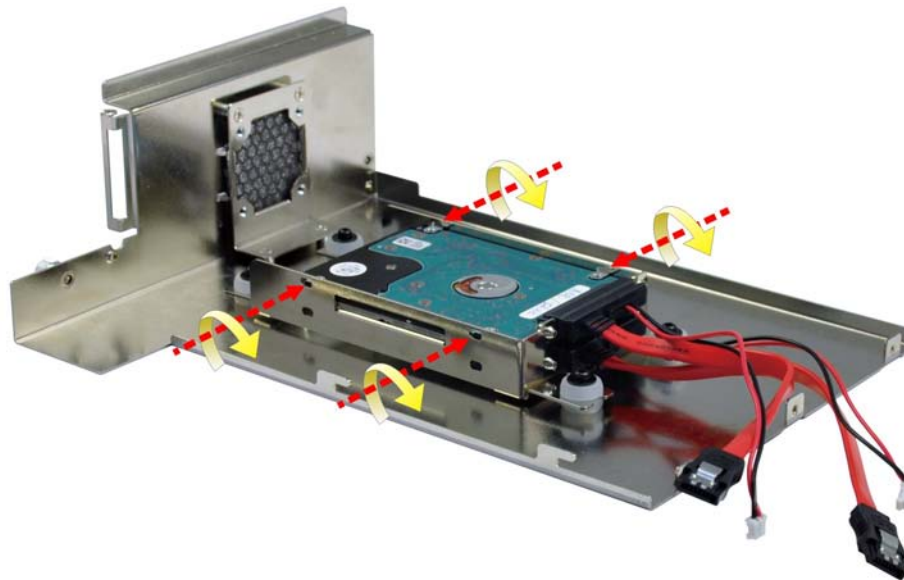

Figure 3-6: HDD Retention Screws

Step 5: Reconnect the SATA signal and power cables to the TANK-860-HM86 Series.

Step 6: Reinstall the cover.

3.4 System Fan Installation

To install the optional system fan, please follow the steps below:

- Step 1:** Remove the two retention screws on the rear panel and loosen the two thumbscrews on the front panel, slide the cover outward, and then lift the cover up gently (**Figure 3-3**).
- Step 2:** Unplug the SATA signal and power cables connected to the TANK-860-HM86 Series, and then place the cover on a flat surface (**Figure 3-4**).
- Step 3:** Attach the system fan to the TANK-860-HM86 Series and secure it by four retention screws (**Figure 3-7**).

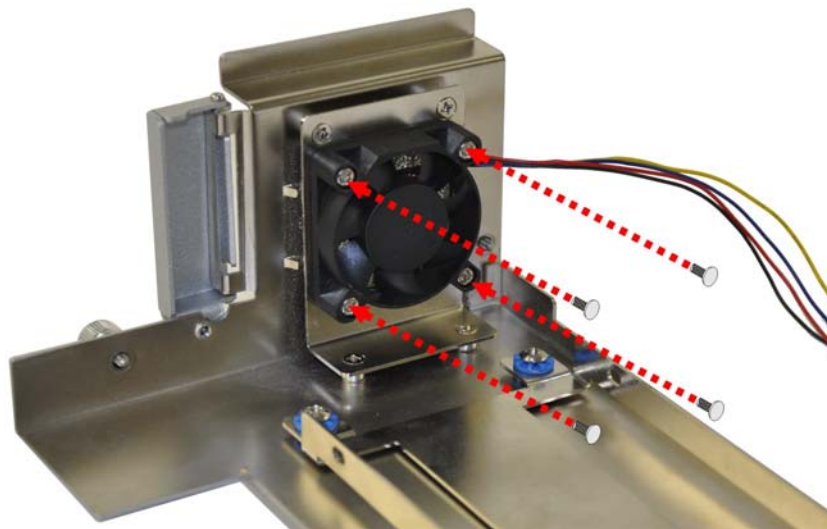

Figure 3-7: System Fan Installation

- Step 4:** Connect the system fan cable to the **CPU_FAN** connector on the motherboard of TANK-860-HM86 Series.
- Step 5:** Reconnect the SATA signal and power cables to the TANK-860-HM86 Series.
- Step 6:** Reinstall the cover.

3.5 Mounting the System with Mounting Brackets

To mount the embedded system onto a wall or some other surface using the two mounting brackets, please follow the steps below.

Step 1: Turn the embedded system to the left side panel.

Step 2: Align the two retention screw holes in each bracket with the corresponding retention screw holes on the bottom surface or the left side panel (**Figure 3-8**).

Left Side Panel



Figure 3-8: Mounting Bracket Retention Screws

Step 3: Secure the brackets to the system by inserting two retention screws into each bracket (**Figure 3-8**).

Step 4: Drill holes in the intended installation surface.

Step 5: Align the mounting holes in the sides of the mounting brackets with the predrilled holes in the mounting surface.

Step 6: Insert four retention screws, two in each bracket, to secure the system to the wall.

3.6 External Peripheral Interface Connectors

The TANK-860-HM86 Series has the following connectors. Detailed descriptions of the connectors can be found in the subsections below.

- ACC mode switch

- AT/ATX power mode switch
- Audio
- CFast Socket
- DIO
- DVI-I
- Ethernet
- Power button
- Power DC jack
- Power terminal block
- Reset button
- RS-232
- RS-232/422/485
- USB
- VGA

3.6.1 ACC Mode Selection

The ACC mode is designed for vehicle applications. The TANK-860-HM86 Series allows turning the ACC mode on or off. The setting can be made through the ACC mode switch on the external peripheral interface panel as shown below.

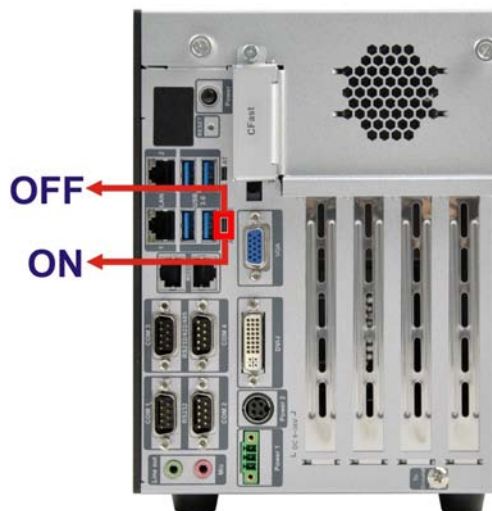

Figure 3-9: ACC Mode Switch

TANK-860-HM86 Embedded System

3.6.2 AT/ATX Power Mode Selection

The TANK-860-HM86 Series supports AT and ATX power modes. The setting can be made through the AT/ATX power mode switch on the external peripheral interface panel as shown below.

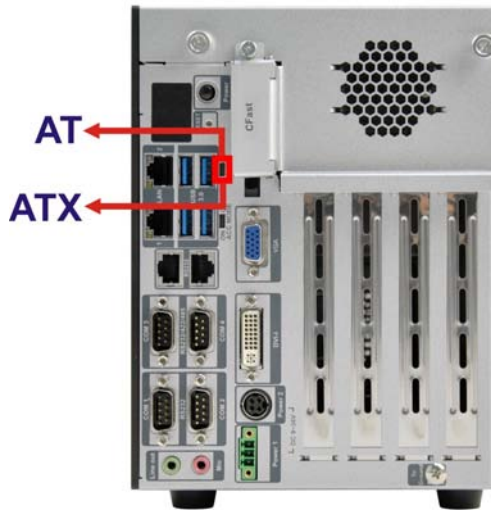

Figure 3-10: AT/ATX Power Mode Switch

3.6.3 Audio Connector

The audio jacks connect to external audio devices.

- **Line Out port (Green):** Connects to a headphone or a speaker. With multi-channel configurations, this port can also connect to front speakers.
- **Microphone (Pink):** Connects a microphone.



Figure 3-11: Audio Connector

3.6.4 CFast Socket

The TANK-860-HM86 Series has one CFast socket. The location of the socket is shown in **Figure 1-2**. To install the CFast card, refer to **Section 3.2**.

3.6.5 Digital Input/Output Connector

The digital I/O connector provides programmable input and output for external devices. The pinouts for the digital I/O connector are listed in the table below.

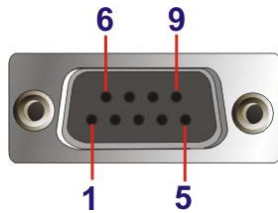

Figure 3-12: DIO Connector

3.6.6 DVI Connector

The TANK-860-HM86 Series has one female DVI-I connector on the front panel. The DVI connectors are connected to digital display devices. To connect a digital display device to the TANK-860-HM86 Series, please follow the instructions below.

- Step 1: Locate the DVI connector.** The location of the DVI connector is shown in **Chapter 1**.
- Step 2: Align the DVI connector.** Align the male DVI connector on the digital display device cable with the female DVI connector on the external peripheral interface.
- Step 3: Insert the DVI connector.** Once the connectors are properly aligned with the male connector, insert the male connector from the digital display device into the female connector on the TANK-860-HM86 Series. See **Figure 3-13**.

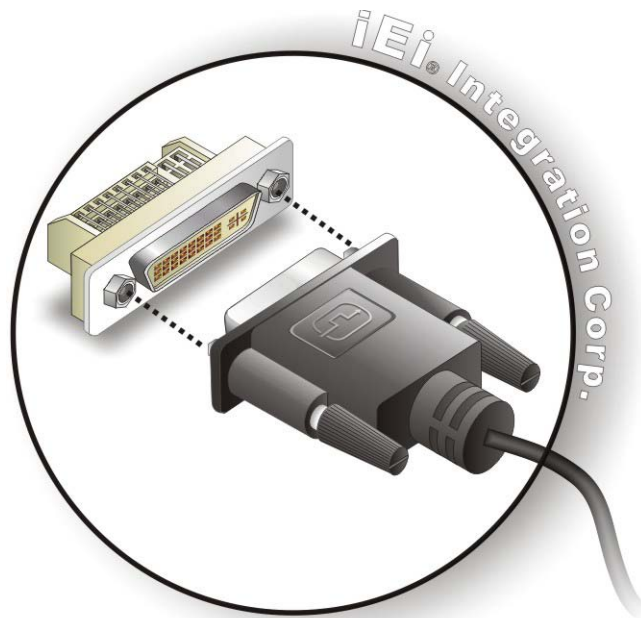

Figure 3-13: DVI Connector

Step 4: Secure the connector. Secure the DVI connector from the digital display device to the external interface by tightening the two retention screws on either side of the connector.

3.6.7 LAN Connectors

The LAN connectors allow connection to an external network.

Step 1: Locate the RJ-45 connectors. The locations of the RJ-45 connectors are shown in **Figure 1-2**.

Step 2: Align the connectors. Align the RJ-45 connector on the LAN cable with one of the RJ-45 connectors on the TANK-860-HM86 Series. See **Figure 3-14**.

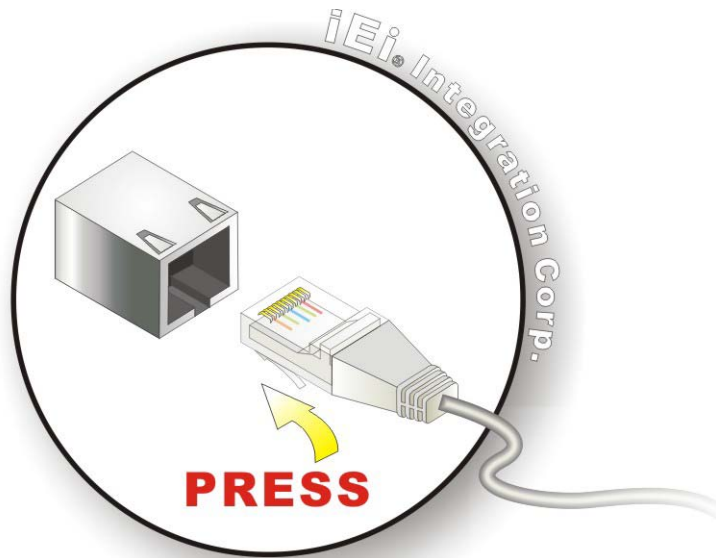

Figure 3-14: LAN Connection

Step 3: Insert the LAN cable RJ-45 connector. Once aligned, gently insert the LAN cable RJ-45 connector into the on-board RJ-45 connector.



Figure 3-15: RJ-45 Ethernet Connector

The RJ-45 Ethernet connector has two status LEDs, one green and one yellow. The green LED indicates activity on the port and the yellow LED indicates the port is linked. See **Table 3-1**.

Activity/Link LED		Speed LED	
STATUS	DESCRIPTION	STATUS	DESCRIPTION
Off	No link	Off	10 Mbps connection
Yellow	Linked	Green	100 Mbps connection
Blinking	TX/RX activity	Orange	1 Gbps connection

Table 3-1: RJ-45 Ethernet Connector LEDs

TANK-860-HM86 Embedded System

3.6.8 Power Input, 3-pin Terminal Block

The power connector connects the leads of a 9 V~36 V DC power supply into the terminal block. Make sure that the power and ground wires are attached to the correct sockets of the connector.

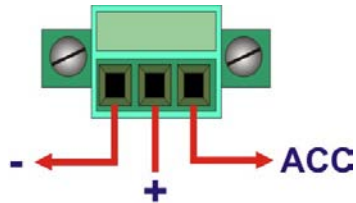

Figure 3-16: 3-pin Terminal Block

3.6.9 Power Input, 4-pin DIN Connector

The power connector connects to the 9 V~36 V DC power adapter.

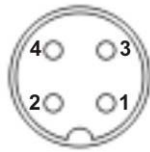

Figure 3-17: Power Input Connector

3.6.10 RJ-45 RS-232 Serial Ports

RS-232 serial port devices can be attached to the RJ-45 RS-232 serial ports on the rear panel.

Step 1: Locate the RJ-45 RS-232 connectors. The locations of the RJ-45 RS-232 connectors are shown in **Figure 1-2**.

Step 2: Insert the RJ-45 connector. Insert the RJ-45 connector on the RJ-45 to DB-9 COM port cable to one of the RJ-45 RS-232 connectors on the TANK-860-HM86 Series. See **Figure 3-18**.

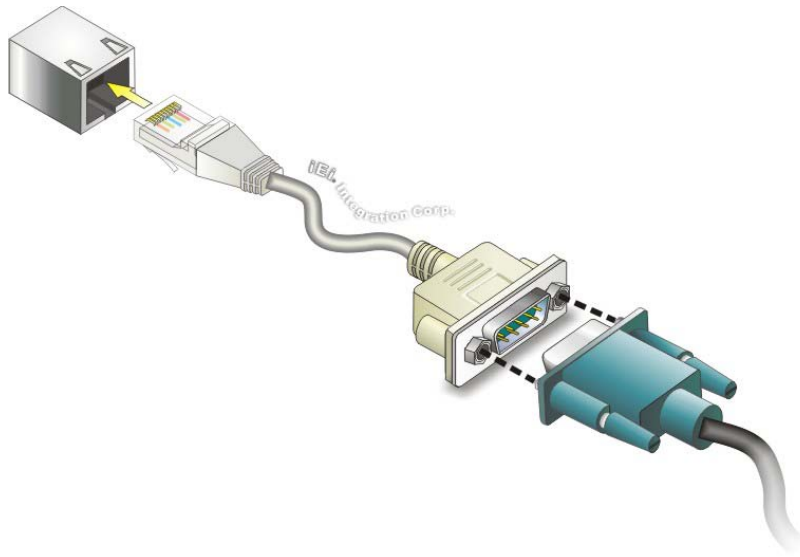

Figure 3-18: RJ-45 RS-232 Serial Device Connection

- Step 3: Insert the serial connector.** Insert the DB-9 connector of a serial device into the DB-9 connector on the RJ-45 to DB-9 COM port cable.
- Step 4: Secure the connector.** Secure the serial device connector to the external interface by tightening the two retention screws on either side of the connector.

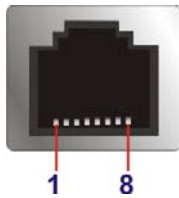

Figure 3-19: RJ-45 RS-232 Serial Port Connector

3.6.11 DB-9 RS-232/422/485 Serial Port Connectors

DB-9 RS-232/422/485 serial port devices can be attached to the DB-9 ports on the rear panel.

- Step 1: Locate the DB-9 connector.** The locations of the DB-9 connectors are shown in **Figure 1-2**.

TANK-860-HM86 Embedded System

Step 2: Insert the serial connector. Insert the DB-9 connector of a serial device into the DB-9 connector on the external peripheral interface. See **Figure 3-20**.

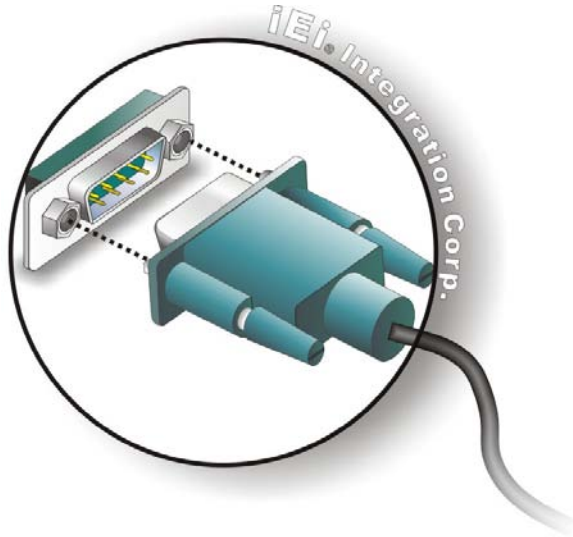

Figure 3-20: Serial Device Connector

Step 3: Secure the connector. Secure the serial device connector to the external interface by tightening the two retention screws on either side of the connector.

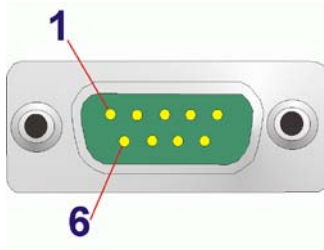

Figure 3-21: DB-9 RS-232/422/485 Serial Port Connector

3.6.12 USB Connectors

The USB ports are for connecting USB peripheral devices to the system.

Step 1: Locate the USB connectors. The locations of the USB connectors are shown in **Figure 1-2**.

Step 2: **Align the connectors.** Align the USB device connector with one of the connectors. See **Figure 3-22**.

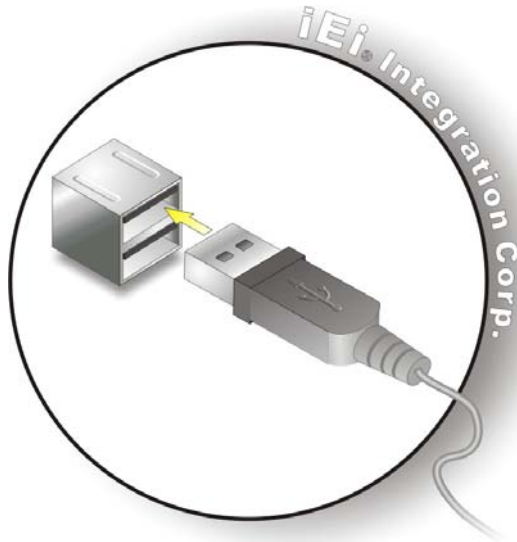

Figure 3-22: USB Device Connection

Step 3: **Insert the device connector.** Once aligned, gently insert the USB device connector into the on-board connector.

3.6.13 VGA Connector

The VGA connector connects to a monitor that accepts VGA video input.

- Step 1:** **Locate the female DB-15 connector.** The location of the female DB-15 connector is shown in **Figure 1-2**.
- Step 2:** **Align the VGA connector.** Align the male DB-15 connector on the VGA screen cable with the female DB-15 connector on the external peripheral interface.
- Step 3:** **Insert the VGA connector** Once the connectors are properly aligned with, insert the male connector from the VGA screen into the female connector on the TANK-860-HM86 Series. See **Figure 3-23**.

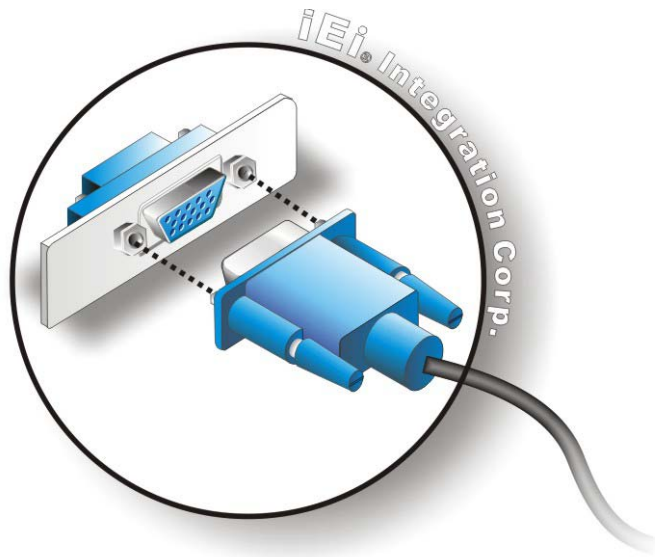

Figure 3-23: VGA Connector

Step 4: **Secure the connector.** Secure the DB-15 VGA connector from the VGA monitor to the external interface by tightening the two retention screws on either side of the connector.

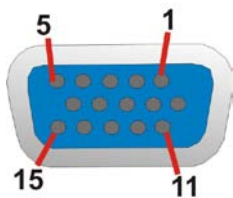

Figure 3-24: VGA Connector

3.7 Powering On/Off the System



WARNING:

Make sure a power supply with the correct input voltage is being fed into the system. Incorrect voltages applied to the system may cause damage to the internal electronic components and may also cause injury to the user.

- **Power on** the system: press the power button for 3 seconds
- **Power off** the system: press the power button for 6 seconds

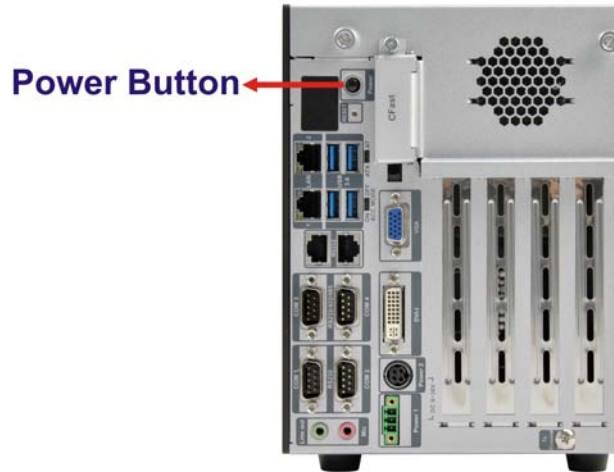

Figure 3-25: Power Button

3.8 Power

There are two power connectors on the rear panel. Power 1 connector is a 3-pin terminal block that supports ACC On signal. Power 2 connector is a DIN connector that can directly connect to a power adapter. The supported power input voltages are:

- **Power 1 (terminal block):** 9 V~ 36 V
- **Power 2 (DC jack):** 9 V ~ 36 V

TANK-860-HM86 Embedded System

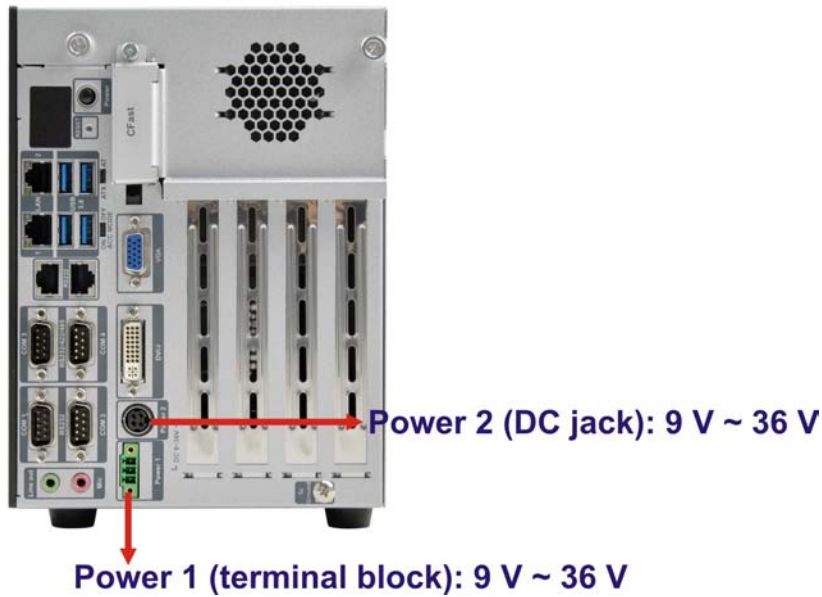

Figure 3-26: Power Connectors

LED Indicator	Description
Power LED1 (Breathing Orange)	Standby mode.
Power LED2 (Solid blue)	Power-on mode.

Table 3-2: Power LED Indicators Description



NOTE:

The power LED turns off when the power cable is unplugged from the system.

3.8.1 ACC ON Mode

1. The TANK-860-HM86 Series supports single power input and also can be simultaneously connected to two power sources. When both power connectors are connected to power sources with 9 V~36 V power input, the one with higher voltage will supply power to the TANK-860.

2. If ACC signal is low, the system will not boot up. If ACC ON signal is high (9 V~36 V), the system will boot up and work normally.
3. If ACC signal jumps from high to low during the power on process, the system will soft shut down and shut down the system power after 10s.
4. When Power 1 < 9 V and Power 2 < 9 V, the system will soft shut down and shut down the system power after 10s.

3.8.2 ACC OFF Mode

1. The TANK-860-HM86 Series supports single power input and also can be simultaneously connected to two power sources. When both power connectors are connected to power sources with 9 V~36 V power input, the one with higher voltage will supply power to the TANK-860.
2. When Power 1 < 9 V and Power 2 < 9 V, the system will soft shut down and shut down the system power after 10s.

Chapter

4

System Motherboard

4.1 Overview

This chapter details all the jumpers and connectors of the system motherboard.

4.1.1 Layout

The figures below show all the connectors and jumpers of the system motherboard. The Pin 1 locations of the on-board connectors are also indicated in the diagram below.

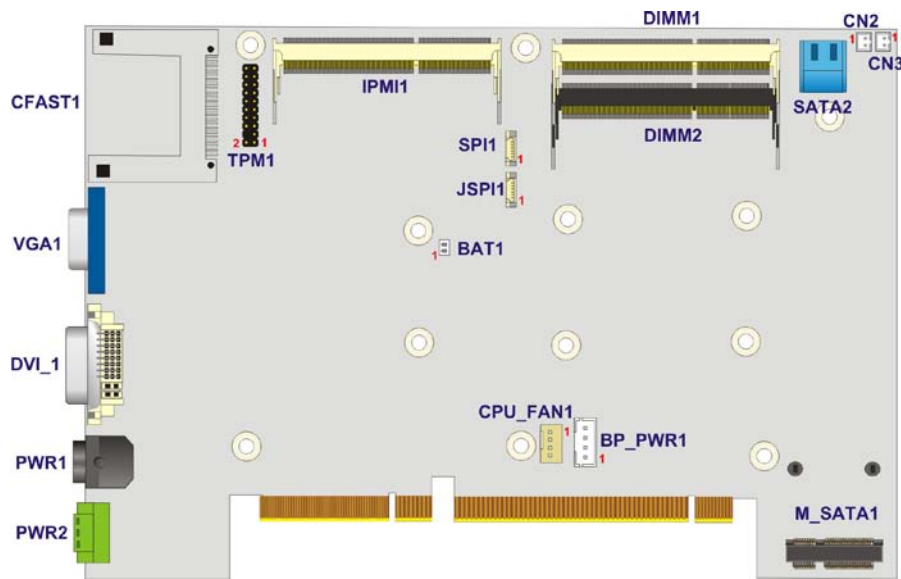

Figure 4-1: System Motherboard (Front)

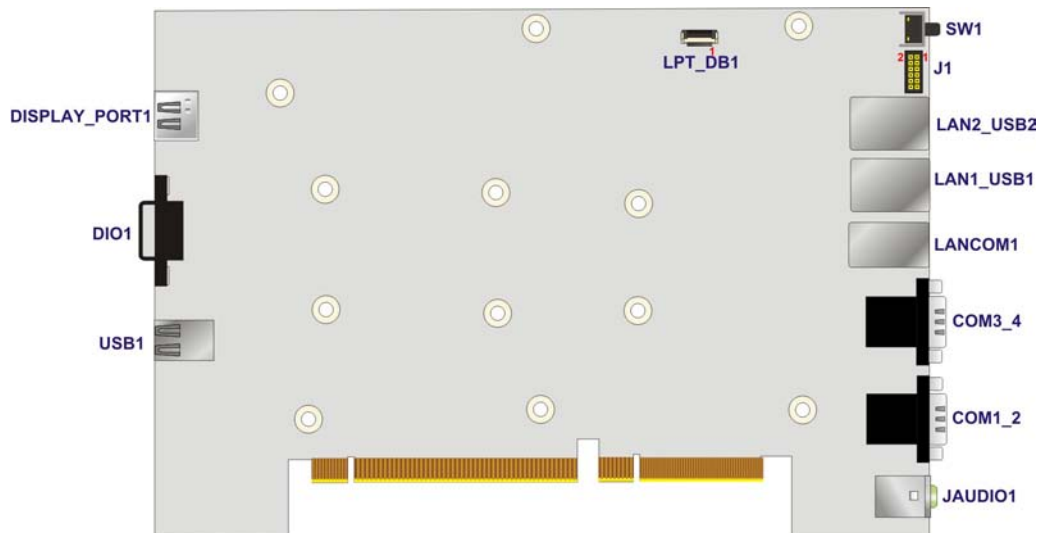

Figure 4-2: System Motherboard (Rear)

4.2 Internal Peripheral Connectors

The table below shows a list of the internal peripheral interface connectors on the system motherboard. Pinouts of these connectors can be found in the following sections.

Connector	Type	Label
Backplane +12V power connector	4-pin wafer	BP_PWR1
Battery connector	2-pin wafer	BAT1
BIOS programming connector	6-pin wafer	SPI1
CFast card connector	CFast socket	CFAST1
CPU fan connector	4-pin wafer	CPU_FAN1
DDR3 SO-DIMM slot	DDR3 SO-DIMM slot	DIMM1, DIMM2
EC debug connector	20-pin FPC connector	LPT_DB1
EC programming connector	6-pin wafer	JSPI1
LED connector	12-pin header	J2
SATA 3Gb/s drive connectors	14-pin SATA connector	SATA2
SATA power connectora	2-pin wafer	CN2, CN3
TPM connector	20-pin header	TPM1

Table 4-1: Peripheral Interface Connectors

4.2.1 Backplane +12V Power Connector (BP_PWR1)

PIN NO.	DESCRIPTION	PIN NO.	DESCRIPTION
1	+12V	2	+12V
3	GND	4	GND

Table 4-2: Backplane +12V Power Connector Pinouts (BP_PWR1)

4.2.2 Battery Connector (BAT1)

PIN NO.	DESCRIPTION
1	VBATT
2	GND

Table 4-3: Battery Connector Pinouts (BAT1)

4.2.3 BIOS Programming Connector (SPI1)

PIN NO.	DESCRIPTION	PIN NO.	DESCRIPTION
1	+SPI_VCC	2	SPI_CS#0_CN
3	SPI_S00_CN	4	SPI_CLK0_CN
5	SPI_S10_CN	6	GND

Table 4-4: BIOS Programming Connector Pinouts (SPI1)

4.2.4 CFast Card connector (CFAST1)

PIN NO.	DESCRIPTION	PIN NO.	DESCRIPTION
S1	GND	S2	SATA_TX2+
S3	SATA_TX2-	S4	GND
S5	SATA_RX2-	S6	SATA_RX2+
S7	GND	PC1	CFAST_EN#
PC2	GND	PC7	GND
PC13	+3.3V	PC14	+3.3V
PC15	GND	PC16	GND

Table 4-5: CFast Card Connector Pinouts (CFAST1)

4.2.5 CPU Fan Connector (CPU_FAN1)

PIN NO.	DESCRIPTION	PIN NO.	DESCRIPTION
1	GND	2	+12V
3	FANIO1	4	FANOUT1

Table 4-6: CPU Fan Connector Pinouts (CPU_FAN1)

4.2.6 EC Debug Connector (LPT_DB1)

PIN NO.	DESCRIPTION	PIN NO.	DESCRIPTION
1	KSI0	11	KSO9
2	KSO0	12	KSO10
3	KSO1	13	KSO12
4	KSO2	14	KSI1
5	KSO3	15	KSO11
6	KSO4	16	KSI2
7	KSO5	17	KSI3
8	KSO6	18	GND
9	KSO7	19	GND
10	KSO8	20	GND

Table 4-7: EC Debug Connector Pinouts (LPT_DB1)

4.2.7 EC Programming Connector (JSPI1)

PIN NO.	DESCRIPTION	PIN NO.	DESCRIPTION
1	+SPI_VCC_EC	2	SPI_CS0#_CN_EC
3	SPI_SO0_CN_EC	4	SPI_CLK0_CN_EC
5	SPI_SIO_CN_EC	6	GND

Table 4-8: EC Programming Connector Pinouts (JSPI1)

4.2.8 LED Connector (J2)

PIN NO.	DESCRIPTION	PIN NO.	DESCRIPTION
1	+V3.3S_LED	2	+V3.3A_EC_LED
3	LRST_PD#	4	LATX_LED#
5	LPWRLED01#	6	LPWRLED02#
7	LIPMI_LED#	8	LCPU_LED#
9	LDISKLED#	10	N/A
11	LED_GND	12	LED_GND

Table 4-9: LED Connector Pinouts (J2)

4.2.9 SATA 3Gb/s Drive Connectors (SATA2)

PIN NO.	DESCRIPTION	PIN NO.	DESCRIPTION
1	GND	2	SATA_TX4+
3	SATA_TX4-	4	GND
5	SATA_RX4-	6	SATA_RX4+
7	GND	8	GND
9	SATA_TX5+	10	SATA_TX5-
11	GND	12	SATA_RX5-
13	SATA_RX5+	14	GND

Table 4-10: SATA 3Gb/s Drive Connectors Pinouts (SATA2)

4.2.10 SATA Power Connectors (CN2, CN3)

PIN NO.	DESCRIPTION
1	+5V
2	GND

Table 4-11: SATA Power Connectors Pinouts (CN2, CN3)

4.2.11 TPM Connector (TPM1)

PIN NO.	DESCRIPTION	PIN NO.	DESCRIPTION
1	TPMPCLK	2	GND
3	LPC_FRAME#		
5	BUF_PCIRST#	6	+5V
7	LPC_AD3	8	LPC_AD2
9	+3.3V	10	LPC_AD1
11	LPC_ADO	12	GND
13	SMBCLK_RESUME	14	SMBDATA_RESUME
15	+3V_DUAL	16	SERIRQ
17	GND	18	+3.3V
19	LPCPD_N	20	LDRQ0#

Table 4-12: TPM Connector Pinouts (TPM1)

4.3 External Interface Panel Connectors

The table below shows a list of the external interface panel connectors on the system motherboard. Pinouts of these connectors can be found in the following sections.

Connector	Type	Label
Audio jack (mic, line-out)	Audio jack	JAUDIO1
DIO connector	DB-9	DIO1
DisplayPort connector	DisplayPort	DISPLAY_PORT1
DVI connector	24-pin female	DVI_I
Ethernet and USB3.0 connectors	RJ-45, USB 3.0 port	LAN1_USB1, LAN2_USB2
Power connector	4-pin DC jack	PWR1
Power connector	3-pin terminal block	PWR2
RS-232 serial port connectors	DB-9	COM1_2
RS-232/422/485 serial port connectors	DB-9	COM3_4
RS-232 serial port connectors	Dual RJ-45	LANCOM1
USB 2.0 connectors	USB 2.0 port	USB1
VGA connector	DB-15	VGA1

Table 4-13: Rear Panel Connectors

4.3.1 Audio Jack (JAUDIO1)

PIN NO.	DESCRIPTION	PIN NO.	DESCRIPTION
1	GND	2	ILMIC1-L
3	GND	4	IMIC1_JD
5	ILMIC1-R	22	ILINE_OUTL
23	GND	24	ISPK_JD
25	ILINE_OUTR		

Table 4-14: Audio Jack Pinouts (AUDIO1)

4.3.2 DIO connector (DIO1)

PIN NO.	DESCRIPTION	PIN NO.	DESCRIPTION
1	DIN0	2	DOUT0
3	DIN1	4	DOUT1
5	DIN2	6	DOUT2
7	DIN3	8	DOUT3
9	+5V		

Table 4-15: DIO connector Pinouts (DIO1)

4.3.3 DisplayPort connector (DISPLAY_PORT1)

PIN NO.	DESCRIPTION	PIN NO.	DESCRIPTION
1	DPD_OB_LANE0_P	2	GND
3	DPD_OB_LANE0_N	4	DPD_OB_LANE1_P
5	GND	6	DPD_OB_LANE1_N
7	DPD_OB_LANE2_P	8	GND
9	DPD_OB_LANE2_N	10	DPD_OB_LANE3_P
11	GND	12	DPD_OB_LANE3_N
13	GND	14	GND
15	DPD_AUX_CTRL_P2	16	GND
17	DPD_AUX_CTRL_N2	18	DDI1_HPD#
19	GND	20	+3.3V

Table 4-16: DisplayPort connector Pinouts (DISPLAY_PORT1)

4.3.4 DVI Connector (DVI_1)

PIN NO.	DESCRIPTION	PIN NO.	DESCRIPTION
1	DVI_TMDS_C_DATA2#	15	GND
2	DVI_TMDS_C_DATA2	16	DVI_HPD
3	GND	17	DVI_TMDS_C_DATA0#
4	NC	18	DVI_TMDS_C_DATA0
5	NC	19	GND
6	DVI_DDC_SCLK	20	NC

TANK-860-HM86 Embedded System

7	DVI_DDC_SDATA	21	NC
8	VSYNC	22	GND
9	DVI_TMDS_C_DATA1#	23	DVI_TMDS_C_CLK
10	DVI_TMDS_C_DATA1	24	DVI_TMDS_C_CLK#
11	GND	C1	RED
12	NC	C2	GREEN
13	NC	C3	BLUE
14	+5V_DVI	C4	HSYNC

Table 4-17: DVI Connector Pinouts (DVI_I)

4.3.5 Ethernet and USB3.0 Connectors (LAN1_USB1)

PIN	DESCRIPTION	PIN	DESCRIPTION
1	VCC	10	VCC
2	USB_DATA-	11	USB_DATA-
3	USB_DATA+	12	USB_DATA+
4	GND	13	GND
5	USB3_RX-	14	USB3_RX-
6	USB3_RX+	15	USB3_RX+
7	GND	16	GND
8	USB3_TX-	17	USB3_TX-
9	USB3_TX+	18	USB3_TX+

Table 4-18: USB 3.0 Port Pinouts (USB1)

PIN	DESCRIPTION	PIN	DESCRIPTION
20	LAN1_MDI0P	24	LAN1_MDI2P
21	LAN1_MDI0N	25	LAN1_MDI2N
22	LAN1_MDI1P	26	LAN1_MDI3P
23	LAN1_MDI1N	27	LAN1_MDI3N

Table 4-19: LAN Pinouts (LAN1)

4.3.6 Ethernet and USB3.0 Connectors (LAN2_USB2)

PIN	DESCRIPTION	PIN	DESCRIPTION
1	VCC	10	VCC

PIN	DESCRIPTION	PIN	DESCRIPTION
2	USB_DATA-	11	USB_DATA-
3	USB_DATA+	12	USB_DATA+
4	GND	13	GND
5	USB3_RX-	14	USB3_RX-
6	USB3_RX+	15	USB3_RX+
7	GND	16	GND
8	USB3_TX-	17	USB3_TX-
9	USB3_TX+	18	USB3_TX+

Table 4-20: USB 3.0 Port Pinouts (USB2)

PIN	DESCRIPTION	PIN	DESCRIPTION
20	LAN2_MDI0P	24	LAN2_MDI2P
21	LAN2_MDI0N	25	LAN2_MDI2N
22	LAN2_MDI1P	26	LAN2_MDI3P
23	LAN2_MDI1N	27	LAN2_MDI3N

Table 4-21: LAN Pinouts (LAN2)

4.3.7 Power Connector (PWR1)

PIN NO.	DESCRIPTION	PIN NO.	DESCRIPTION
1	+VIN	2	GND
3	+VIN	4	GND
5	GND		

Table 4-22: Power Connector Pinouts (PWR2)

4.3.8 Power Connector (PWR2)

PIN NO.	DESCRIPTION	PIN NO.	DESCRIPTION
1	ACCON	2	+VIN
3	GND		

Table 4-23: Power Connector Pinouts (PWR1)

4.3.9 RS-232 Serial Port Connector (COM1_2)

PIN NO.	DESCRIPTION	PIN NO.	DESCRIPTION
1	NDCD#	2	NRXD
3	NTXD	4	NDTR#
5	GND	6	NDSR#
7	NRTS#	8	NCTS#
9	NRI#		

Table 4-24: RS-232 Serial Port Connector Pinouts (COM1)

PIN NO.	DESCRIPTION	PIN NO.	DESCRIPTION
10	NDCD2#	11	NRXD2
12	NTXD2	13	NDTR2#
14	GND	15	NDSR2#
16	NRTS2#	17	NCTS2#
18	NRI2#		

Table 4-25: RS-232 Serial Port Connector Pinouts (COM2)

4.3.10 RS-232/422/485 Serial Port Connector (COM3_4)

PIN NO.	DESCRIPTION	PIN NO.	DESCRIPTION
1	NDCD3/RX+	2	NRXD3/RX-
3	NTXD3/TX+	4	NDTR3/TX-
5	GND	6	NDSR3
7	NRTS3	8	NCTS3
9	NRI3	10	NDCD4/RX+
11	NRXD4/RX-	12	NTXD4/TX+
13	NDTR4/TX-	14	GND
15	NDSR4	16	NRTS4
17	NCTS4	18	NRI4

Table 4-26: RS-232/422/485 Serial Port Connector Pinouts (COM3_4)

4.3.11 RS-232 Serial Port Connectors (LANCOM1)

PIN NO.	DESCRIPTION	PIN NO.	DESCRIPTION
---------	-------------	---------	-------------

A1	NRI5	A2	NDTR5
A3	NCTS5	A4	NTXD5
A5	NRTS5	A6	NRXD5
A7	NDSR5	A8	NDCD5
B1	NRI6	B2	NDTR6
B3	NCTS6	B4	NTXD6
B5	NRTS6	B6	NRXD6
B7	NDSR6	B8	NDCD6

Table 4-27: RS-232 Serial Port Connectors Pinouts (LANCOM1)

4.3.12 USB 2.0 Connectors (USB1)

PIN NO.	DESCRIPTION	PIN NO.	DESCRIPTION
1	+5V	2	GND
3	USB20_C_N10	4	USB20_C_P11
5	USB20_C_P10	6	USB20_C_N11
7	GND	8	+5V

Table 4-28: USB 2.0 Connectors Pinouts (USB1)

4.3.13 VGA Connector (VGA1)

PIN NO.	DESCRIPTION	PIN NO.	DESCRIPTION
1	Red	2	Green
3	Blue	4	NC
5	GND	6	GND
7	GND	8	GND
9	VGAVCC	10	HOTPLUG
11	NC	12	DDCDAT
13	HSYNC	14	VSYNC
15	DDCCLK		

Table 4-29: VGA Connector Pinouts (VGA1)

Chapter

5

BIOS

5.1 Introduction

The BIOS is programmed onto the BIOS chip. The BIOS setup program allows changes to certain system settings. This chapter outlines the options that can be changed.



NOTE:

Some of the BIOS options may vary throughout the life cycle of the product and are subject to change without prior notice.

5.1.1 Starting Setup

The UEFI BIOS is activated when the computer is turned on. The setup program can be activated in one of two ways.

1. Press the **DEL** or **F2** key as soon as the system is turned on or
2. Press the **DEL** or **F2** key when the “**Press DEL or F2 to enter SETUP**” message appears on the screen.

If the message disappears before the **DEL** or **F2** key is pressed, restart the computer and try again.

5.1.2 Using Setup

Use the arrow keys to highlight items, press **ENTER** to select, use the PageUp and PageDown keys to change entries, press **F1** for help and press **ESC** to quit. Navigation keys are shown in.

Key	Function
Up arrow	Move to previous item
Down arrow	Move to next item
Left arrow	Move to the item on the left hand side
Right arrow	Move to the item on the right hand side
+	Increase the numeric value or make changes

Key	Function
-	Decrease the numeric value or make changes
Page Up key	Increase the numeric value or make changes
Page Dn key	Decrease the numeric value or make changes
Esc key	Main Menu – Quit and not save changes into CMOS Status Page Setup Menu and Option Page Setup Menu -- Exit current page and return to Main Menu
F1	General help, only for Status Page Setup Menu and Option Page Setup Menu
F2	Previous values
F3	Load optimized defaults
F4	Save changes and Exit BIOS

Table 5-1: BIOS Navigation Keys

5.1.3 Getting Help

When **F1** is pressed a small help window describing the appropriate keys to use and the possible selections for the highlighted item appears. To exit the Help Window press **Esc** or the **F1** key again.

5.1.4 Unable to Reboot after Configuration Changes

If the computer cannot boot after changes to the system configuration is made, CMOS defaults. Use the jumper described in Chapter 2.

5.1.5 BIOS Menu Bar

The **menu bar** on top of the BIOS screen has the following main items:

- Main – Changes the basic system configuration.
- Advanced – Changes the advanced system settings.
- Chipset – Changes the chipset settings.
- Boot – Changes the system boot configuration.
- Security – Sets User and Supervisor Passwords.

- Save & Exit – Selects exit options and loads default settings.

The following sections completely describe the configuration options found in the menu items at the top of the BIOS screen and listed above.

TANK-860-HM86 Embedded System

5.2 Main

The **Main** BIOS menu (**BIOS Menu 1**) appears when the **BIOS Setup** program is entered.

The **Main** menu gives an overview of the basic system information.

Aptio Setup Utility - Copyright (C) 2011 American Megatrends, Inc.			
Main	Advanced	Chipset	Boot Security Save & Exit
BIOS Information			
BIOS Vendor	American Megatrends		Set the Date. Use Tab to switch between Data elements.
Core Version	4.6.5.4		
Compliancy	UEFI 2.3.1; PI 1.2		
Project Version	SED7AR10.bin		
Build Date	08/11/2014 12:38:08		
iWDD Vendor	iEi		
iWDD Version	SED7ER10.BIN		
IPMI Card Status	Not Present		
Processor Information			
Name	Haswell		
Brand String	Intel(R) Core(TM) i5-4400E CPU @ 2.70GHz		
Frequency	3200 MHz		
Processor ID	306c3		
Stepping	C0		
Number of Processors	2Core(s) / 4Thread(s)		
Microcode Revision	12		
GT Info	GT2 (800 MHz)		
IGFX VBIOS Version	2178		
Memory RC Version	1.6.1.2		
Total Memory	4096 MB (DDR3)		
Memory Frequency	1333 MHz		
PCH Information			
Name	LynxPoint		
PCH SKU	HM86		←→: Select Screen
Stepping	05/C2		↑ ↓: Select Item
LAN PHY Revision	A3		EnterSelect
ME FW Version	9.0.13.1402		+/-: Change Opt.
ME Firmware SKU	1.5MB		F1: General Help
			F2: Previous Values
			F3: Optimized Defaults
			F4: Save & Exit
			ESC: Exit
SPI Clock Frequency			
DOFR Support	Supported		
Read Status Clock Frequency	50 MHz		
Write Status Clock Frequency	50 MHz		
Fast Read Status Clock Frequency	50 MHz		
System Date	[Wed 10/09/2014]		
System Time	[15:43:27]		
Access Level	Administrator		
Version 2.14.1219. Copyright (C) 2011 American Megatrends, Inc.			

BIOS Menu 1: Main

The Main menu lists the following system details:

- BIOS Information
- Processor Information
- Memory Information
- PCH Information
- SPI Clock Frequency

The Main menu has two user configurable fields:

→ System Date [xx/xx/xx]

Use the **System Date** option to set the system date. Manually enter the day, month and year.

→ System Time [xx:xx:xx]

Use the **System Time** option to set the system time. Manually enter the hours, minutes and seconds.

5.3 Advanced

Use the **Advanced** menu (**BIOS Menu 2**) to configure the CPU and peripheral devices through the following sub-menus:



WARNING!

Setting the wrong values in the sections below may cause the system to malfunction. Make sure that the settings made are compatible with the hardware.

TANK-860-HM86 Embedded System

```

Aptio Setup Utility - Copyright (C) 2011 American Megatrends, Inc.
Main  Advanced  Chipset  Boot  Security  Save & Exit
-----
> ACPI Settings
> RTC Wake Settings
> Trusted Computing
> CPU Configuration
> SATA Configuration
> Intel(R)Rapid Start Technology
> USB Configuration
> F81866 Super IO Configuration
> F81866 H/M Monitor
> Serial Port Console Redirection
> iEi Feature

System ACPI Parameters
-----
<=>: Select Screen
↑↓: Select Item
EnterSelect
+/-: Change Opt.
F1: General Help
F2: Previous Values
F3: Optimized Defaults
F4: Save & Exit
ESC: Exit

Version 2.14.1219. Copyright (C) 2011 American Megatrends, Inc.

```

BIOS Menu 2: Advanced

5.3.1 ACPI Settings

The **ACPI Settings** menu (**BIOS Menu 3**) configures the Advanced Configuration and Power Interface (ACPI) options.

```

Aptio Setup Utility - Copyright (C) 2011 American Megatrends, Inc.
Advanced
-----
ACPI Settings
ACPI Sleep State          [S1 (CPU Stop Clock)]

Select ACPI sleep state
the system will enter
when the SUSPEND button
is pressed.
-----
<=>: Select Screen
↑↓: Select Item
EnterSelect
+/-: Change Opt.
F1: General Help
F2: Previous Values
F3: Optimized Defaults
F4: Save & Exit
ESC: Exit

Version 2.14.1219. Copyright (C) 2011 American Megatrends, Inc.

```

BIOS Menu 3: ACPI Configuration

➔ ACPI Sleep State [S1 (CPU Stop Clock)]

Use the **ACPI Sleep State** option to specify the sleep state the system enters when it is not being used.

➔ **S1 (CPU Stop Clock)** **DEFAULT** The system enters S1(POS) sleep state. The system appears off. The CPU is stopped; RAM is refreshed; the system is running in a low power mode.

➔ **S3 (Suspend to RAM)** The caches are flushed and the CPU is powered off. Power to the RAM is maintained. The computer returns slower to a working state, but more power is saved.

5.3.2 RTC Wake Settings

The **RTC Wake Settings** menu (**BIOS Menu 4**) configures RTC wake event.

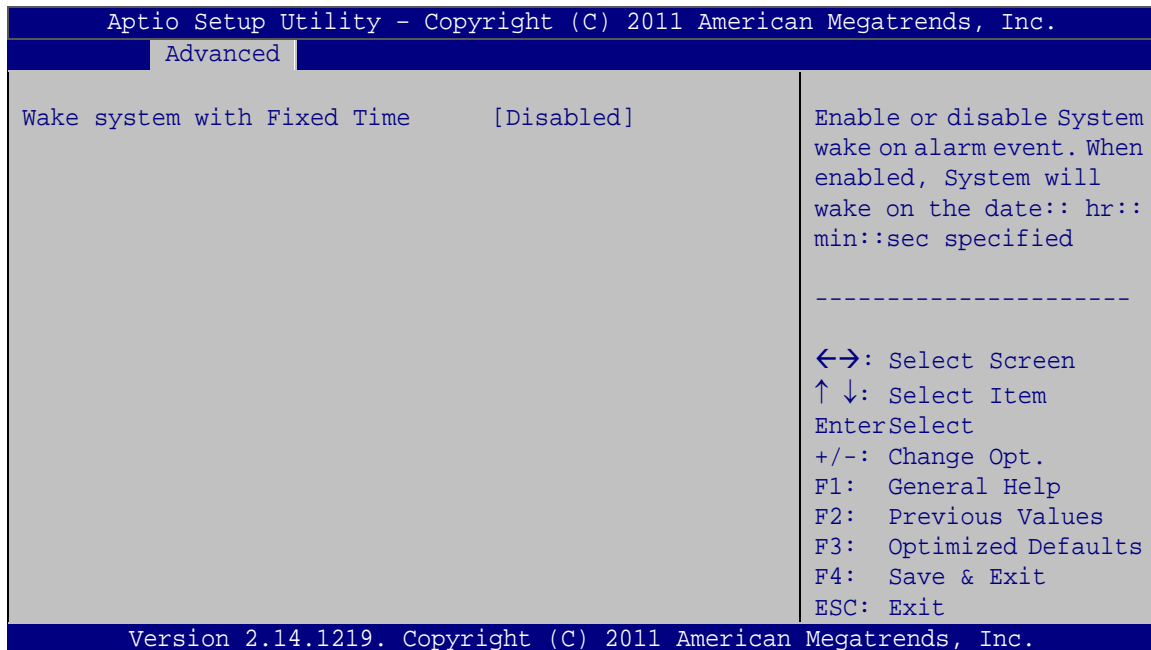

BIOS Menu 4: RTC Wake Settings

TANK-860-HM86 Embedded System

→ Wake System with Fixed Time [Disabled]

Use the **Wake System with Fixed Time** option to specify the time the system should be roused from a suspended state.

→ **Disabled** **DEFAULT** The real time clock (RTC) cannot generate a wake event

→ **Enabled** If selected, the following appears with values that can be selected:

*Wake up every day

*Wake up date

*Wake up hour

*Wake up minute

*Wake up second

After setting the alarm, the computer turns itself on from a suspend state when the alarm goes off.

5.3.3 Trusted Computing

Use the **Trusted Computing** menu (**BIOS Menu 5**) to configure settings related to the Trusted Computing Group (TCG) Trusted Platform Module (TPM).

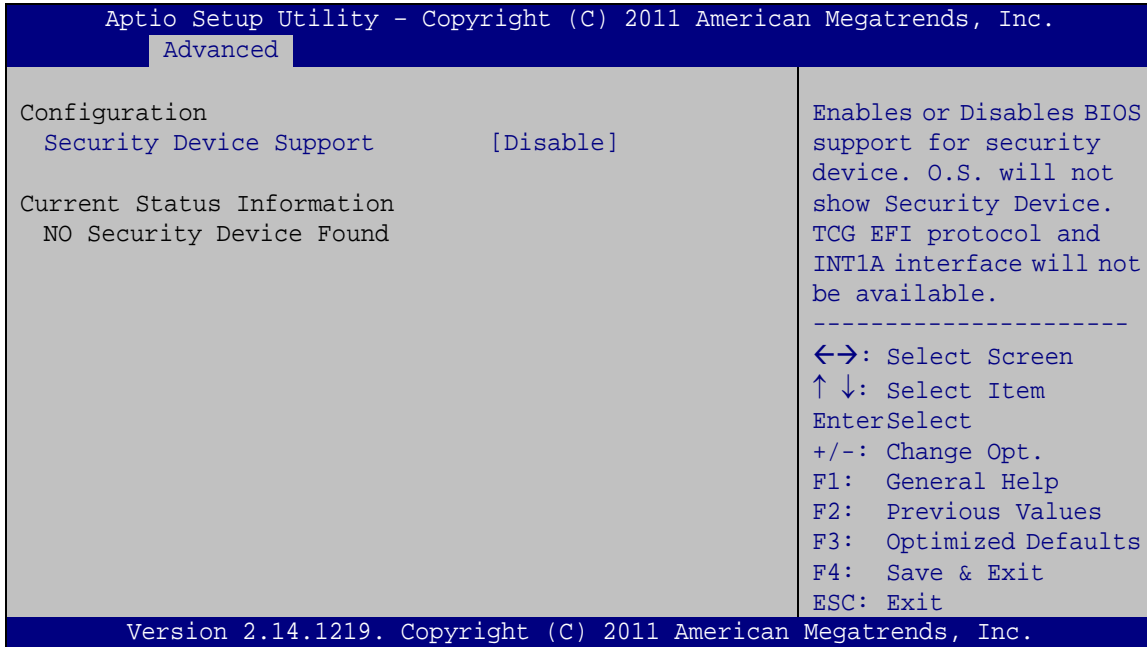

BIOS Menu 5: Trusted Computing

➔ Security Device Support [Disable]

Use the **Security Device Support** option to configure support for the security device.

➔ **Disable** **DEFAULT** Security device support is disabled.

➔ **Enable** Security device support is enabled.

5.3.4 CPU Configuration

Use the **CPU Configuration** menu (**BIOS Menu 6**) to enter the **CPU Information** submenu or enable Intel Virtualization Technology.

TANK-860-HM86 Embedded System

Aptio Setup Utility - Copyright (C) 2011 American Megatrends, Inc.

Advanced

CPU Configuration	
Intel(R) Core(TM) i5-4400E CPU @ 2.70GHz	
CPU Signature	306c3
Processor Family	6
Microcode Patch	12
FSB Speed	100 MHz
Max CPU Speed	2700 MHz
Min CPU Speed	800 MHz
CPU Speed	3200 MHz
Processor Cores	2
Intel HT Technology	Supported
Intel VT-x Technology	Supported
Intel SMX Technology	Supported
64-bit	Supported
EIST Technology	Supported
CPU C3 Technology	Supported
CPU C6 Technology	Supported
CPU C7 Technology	Supported
L1 Data Cache	32 kB x 2
L1 Code Cache	32 kB x 2
L2 Cache	256 kB x 2
L3 Cache	3072 kB
Hyper-threading	[Enabled]
Active Processor Cores	[All]
Intel Virtualization Technology	[Disabled]
EIST	[Enabled]
Intel TXT(LT) Support	[Disabled]

←→: Select Screen

↑ ↓: Select Item

Enter>Select

+/-: Change Opt.

F1: General Help

F2: Previous Values

F3: Optimized Defaults

F4: Save & Exit

ESC: Exit

Version 2.14.1219. Copyright (C) 2011 American Megatrends, Inc.

BIOS Menu 6: CPU Configuration

The CPU Configuration menu (**BIOS Menu 6**) lists the following CPU details:

- Processor Type: Lists the brand name of the CPU being used
- CPU Signature: Lists the CPU signature value.
- Processor Family: Lists the processor family value.
- Microcode Patch: Lists the microcode patch being used.
- FSB Speed: Lists the FSB speed.
- Max CPU Speed: Lists the maximum CPU processing speed.
- Min CPU Speed: Lists the minimum CPU processing speed.
- CPU Speed: Lists the CPU processing speed.
- Processor Cores: Lists the number of the processor core

- Intel HT Technology: Indicates if Intel HT Technology is supported by the CPU.
- Intel VT-x Technology: Indicates if Intel VT-x Technology is supported by the CPU.
- Intel SMX Technology: Indicates if Intel SMX Technology is supported by the CPU.
- 64-bit: Indicates if 64-bit is supported by the CPU.
- EIST Technology: Indicates if EIST Technology is supported by the CPU.
- CPU C3 state: Indicates if C3 state is supported by the CPU.
- CPU C6 state: Indicates if C6 state is supported by the CPU.
- CPU C7 state: Indicates if C7 state is supported by the CPU.
- L1 Data Cache: Lists the amount of data storage space on the L1 cache.
- L1 Code Cache: Lists the amount of code storage space on the L1 cache.
- L2 Cache: Lists the amount of storage space on the L2 cache.
- L3 Cache: Lists the amount of storage space on the L3 cache.

➔ Hyper-threading [Enabled]

Use the **Hyper-threading** BIOS option to enable or disable the Intel Hyper-Threading Technology.

➔ **Disabled** Disables the Intel Hyper-Threading Technology.

➔ **Enabled** **DEFAULT** Enables the Intel Hyper-Threading Technology.

➔ Active Processor Cores [All]

Use the **Active Processor Cores** option to configure the number of the active processor cores.

➔ **All** **DEFAULT** Active all of the processor cores

➔ **1** Active one of the processor cores

➔ **2** Active two of the processor cores

➔ **3** Active three of the processor cores

TANK-860-HM86 Embedded System

→ Intel Virtualization Technology [Disabled]

Use the **Intel Virtualization Technology** option to enable or disable virtualization on the system. When combined with third party software, Intel Virtualization technology allows several OSs to run on the same system at the same time.

→ **Disabled** **DEFAULT** Disables Intel Virtualization Technology.

→ **Enabled** Enables Intel Virtualization Technology.

→ EIST [Enabled]

Use the **EIST** option to enable or disable the Intel Speed Step Technology.

→ **Disabled** Disables the Intel Speed Step Technology.

→ **Enabled** **DEFAULT** Enables the Intel Speed Step Technology.

→ Intel TXT(LT) Support [Disabled]

Use the **Intel TXT(LT) Support** option to enable or disable the Intel® Trusted Execution Technology.

→ **Disabled** **DEFAULT** Disables the Intel® Trusted Execution Technology.

→ **Enabled** Enables the Intel® Trusted Execution Technology.

5.3.5 SATA Configuration

Use the **SATA Configuration** menu (**BIOS Menu 7**) to change and/or set the configuration of the SATA devices installed in the system.

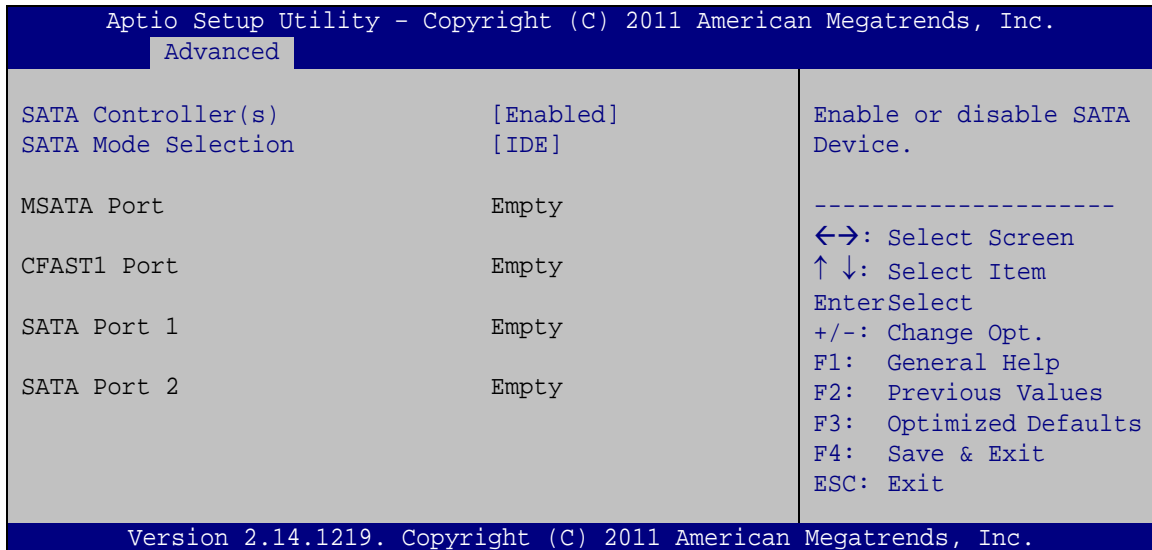

BIOS Menu 7: SATA Configuration

→ SATA Controller(s) [Enabled]

Use the **SATA Controller(s)** option to configure the serial ATA controller.

- **Enabled** **DEFAULT** Enables the on-board SATA controller.
- **Disabled** Disables the on-board SATA controller.

→ SATA Mode Selection [IDE]

Use the **SATA Selection Mode** option to configure SATA devices as normal IDE devices.

- **IDE** **DEFAULT** Configures SATA devices as normal IDE device.
- **AHCI** Configures SATA devices as AHCI device.

5.3.6 Intel(R) Rapid Start Technology

Use the **Intel(R) Rapid Start Technology** menu (**BIOS Menu 8**) to configure Intel® Rapid Start Technology support.

TANK-860-HM86 Embedded System

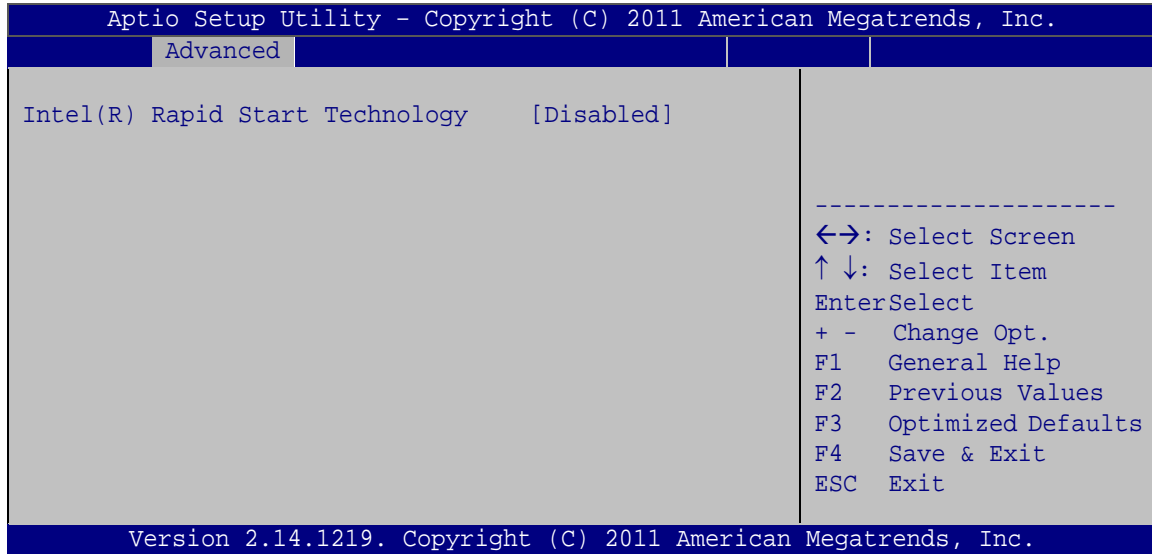

BIOS Menu 8: Intel(R) Rapid Start Technology

→ Intel(R) Rapid Start Technology [Disabled]

Use **Intel(R) Rapid Start Technology** option to configure Intel® Rapid Start Technology function.

- **Disabled** **DEFAULT** Intel® Rapid Start Technology is disabled
- **Enabled** Intel® Rapid Start Technology is enabled

5.3.7 USB Configuration

Use the **USB Configuration** menu (**BIOS Menu 9**) to read USB configuration information and configure the USB settings.

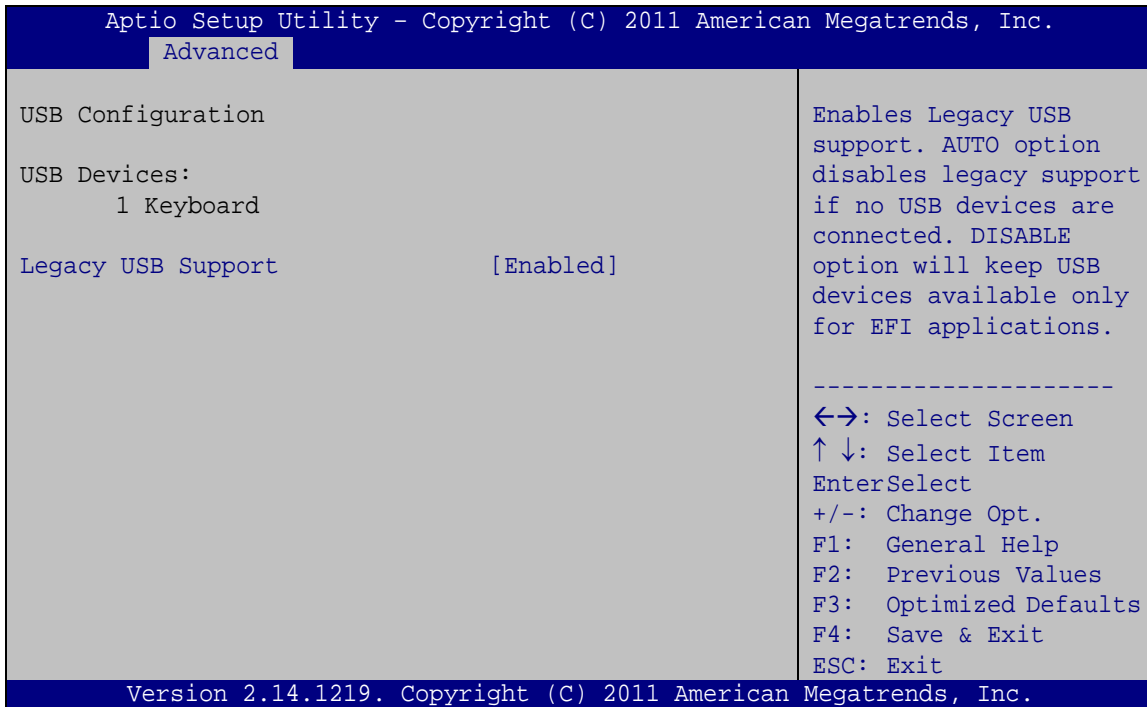

BIOS Menu 9: USB Configuration

→ USB Devices

The **USB Devices** field lists the USB devices that are enabled on the system

→ Legacy USB Support [Enabled]

Use the **Legacy USB Support** BIOS option to enable USB mouse and USB keyboard support. Normally if this option is not enabled, any attached USB mouse or USB keyboard does not become available until a USB compatible operating system is fully booted with all USB drivers loaded. When this option is enabled, any attached USB mouse or USB keyboard can control the system even when there is no USB driver loaded onto the system.

→ **Enabled** **DEFAULT** Legacy USB support enabled

TANK-860-HM86 Embedded System

- ➔ **Disabled** Legacy USB support disabled
- ➔ **Auto** Legacy USB support disabled if no USB devices are connected

5.3.8 F81866 Super IO Configuration

Use the **F81866 Super IO Configuration** menu (**BIOS Menu 10**) to set or change the configurations for the serial ports.

```

Aptio Setup Utility - Copyright (C) 2011 American Megatrends, Inc.
  Advanced
F81866 Super IO Configuration
F81866 Super IO Chip          F81866
> Serial Port 1 Configuration
> Serial Port 2 Configuration
> Serial Port 3 Configuration
> Serial Port 4 Configuration
> Serial Port 5 Configuration
> Serial Port 6 Configuration
Set Parameters of Serial Port 1 (COMA)
-----
<->: Select Screen
↑ ↓: Select Item
Enter: Select
+/-: Change Opt.
F1: General Help
F2: Previous Values
F3: Optimized Defaults
F4: Save & Exit
ESC: Exit
Version 2.14.1219. Copyright (C) 2011 American Megatrends, Inc.
  
```

BIOS Menu 10: F81866 Super IO Configuration

5.3.8.1 Serial Port n Configuration

Use the **Serial Port n Configuration** menu (**BIOS Menu 11**) to configure the serial port n.

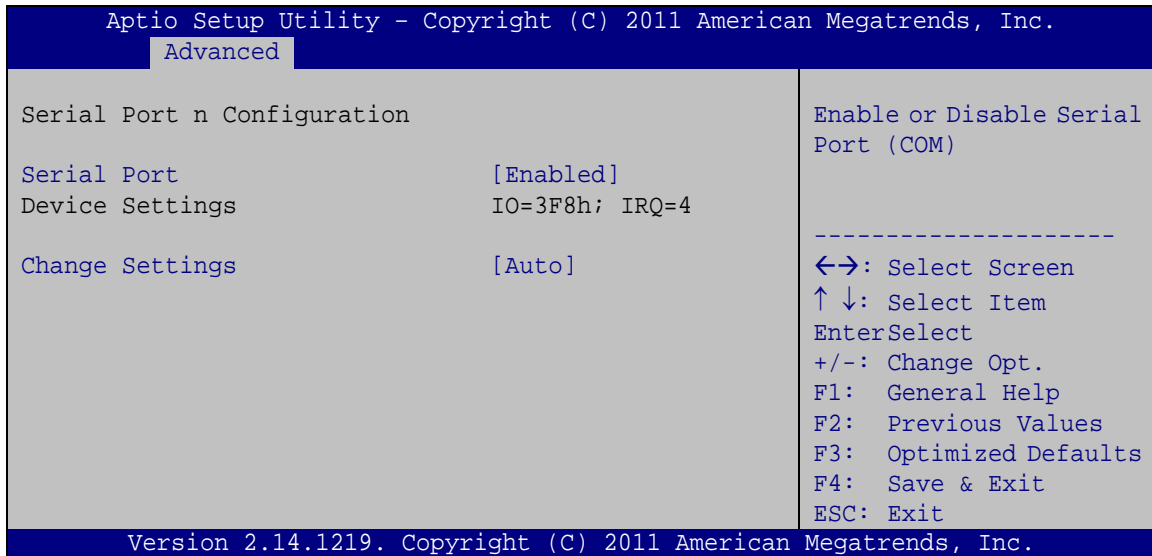

BIOS Menu 11: Serial Port n Configuration Menu

5.3.8.1.1 Serial Port 1 Configuration

→ Serial Port [Enabled]

Use the **Serial Port** option to enable or disable the serial port.

- **Disabled** Disable the serial port
- **Enabled** **DEFAULT** Enable the serial port

→ Change Settings [Auto]

Use the **Change Settings** option to change the serial port IO port address and interrupt address.

- **Auto** **DEFAULT** The serial port IO port address and interrupt address are automatically detected.
- **IO=3F8h;**
IRQ=4 Serial Port I/O port address is 3F8h and the interrupt address is IRQ4

TANK-860-HM86 Embedded System

- ➔ **IO=3F8h;** Serial Port I/O port address is 3F8h and the interrupt
IRQ=3, 4 address is IRQ3, 4
- ➔ **IO=2F8h;** Serial Port I/O port address is 2F8h and the interrupt
IRQ=3, 4 address is IRQ3, 4

5.3.8.1.2 Serial Port 2 Configuration

- ➔ Serial Port [Enabled]

Use the **Serial Port** option to enable or disable the serial port.

- ➔ **Disabled** Disable the serial port
- ➔ **Enabled** **DEFAULT** Enable the serial port

- ➔ Change Settings [Auto]

Use the **Change Settings** option to change the serial port IO port address and interrupt address.

- ➔ **Auto** **DEFAULT** The serial port IO port address and interrupt address
are automatically detected.
- ➔ **IO=2F8h;** Serial Port I/O port address is 2F8h and the interrupt
IRQ=3 address is IRQ3
- ➔ **IO=3F8h;** Serial Port I/O port address is 3F8h and the interrupt
IRQ=3, 4 address is IRQ3, 4
- ➔ **IO=2F8h;** Serial Port I/O port address is 2F8h and the interrupt
IRQ=3, 4 address is IRQ3, 4

5.3.8.1.3 Serial Port 3 Configuration

- ➔ Serial Port [Enabled]

Use the **Serial Port** option to enable or disable the serial port.

- ➔ **Disabled** Disable the serial port

→ **Enabled** **DEFAULT** Enable the serial port

→ Change Settings [Auto]

Use the **Change Settings** option to change the serial port IO port address and interrupt address.

→ **Auto** **DEFAULT** The serial port IO port address and interrupt address are automatically detected.

→ **IO=3E8h;**
IRQ=10 Serial Port I/O port address is 3E8h and the interrupt address is IRQ10

→ **IO=3E8h;**
IRQ=10, 11 Serial Port I/O port address is 3E8h and the interrupt address is IRQ10, 11

→ **IO=2E8h;**
IRQ=10, 11 Serial Port I/O port address is 2E8h and the interrupt address is IRQ10, 11

→ Device Mode [RS232]

Use the **Device Mode** option to select the serial port mode.

→ **RS232** **DEFAULT** Enables serial port RS-232 support.

→ **RS422** Enables serial port RS-422 support.

→ **RS485** Enables serial port RS-485 support.

5.3.8.1.4 Serial Port 4 Configuration

→ Serial Port [Enabled]

Use the **Serial Port** option to enable or disable the serial port.

→ **Disabled** Disable the serial port

→ **Enabled** **DEFAULT** Enable the serial port

TANK-860-HM86 Embedded System

→ Change Settings [Auto]

Use the **Change Settings** option to change the serial port IO port address and interrupt address.

- | | | | |
|---|--------------------------------|----------------|---|
| → | Auto | DEFAULT | The serial port IO port address and interrupt address are automatically detected. |
| → | IO=2E8h;
IRQ=10 | | Serial Port I/O port address is 2E8h and the interrupt address is IRQ10 |
| → | IO=3E8h;
IRQ=10, 11 | | Serial Port I/O port address is 3E8h and the interrupt address is IRQ10, 11 |
| → | IO=2E8h;
IRQ=10, 11 | | Serial Port I/O port address is 2E8h and the interrupt address is IRQ10, 11 |

→ Device Mode [RS232]

Use the **Device Mode** option to select the serial port mode.

- | | | | |
|---|--------------|----------------|-------------------------------------|
| → | RS232 | DEFAULT | Enables serial port RS-232 support. |
| → | RS422 | | Enables serial port RS-422 support. |
| → | RS485 | | Enables serial port RS-485 support. |

5.3.8.1.5 Serial Port 5 Configuration

→ Serial Port [Enabled]

Use the **Serial Port** option to enable or disable the serial port.

- | | | | |
|---|-----------------|----------------|-------------------------|
| → | Disabled | | Disable the serial port |
| → | Enabled | DEFAULT | Enable the serial port |

→ Change Settings [Auto]

Use the **Change Settings** option to change the serial port IO port address and interrupt address.

- ➔ **Auto** **DEFAULT** The serial port IO port address and interrupt address are automatically detected.
- ➔ **IO=2D0h;**
IRQ=10 Serial Port I/O port address is 2D0h and the interrupt address is IRQ10
- ➔ **IO=2D0h;**
IRQ=10, 11 Serial Port I/O port address is 2D0h and the interrupt address is IRQ10, 11
- ➔ **IO=2D8h;**
IRQ=10, 11 Serial Port I/O port address is 2D8h and the interrupt address is IRQ10, 11

5.3.8.1.6 Serial Port 6 Configuration

➔ Serial Port [Enabled]

Use the **Serial Port** option to enable or disable the serial port.

- ➔ **Disabled** Disable the serial port
- ➔ **Enabled** **DEFAULT** Enable the serial port

➔ Change Settings [Auto]

Use the **Change Settings** option to change the serial port IO port address and interrupt address.

- ➔ **Auto** **DEFAULT** The serial port IO port address and interrupt address are automatically detected.
- ➔ **IO=2D8h;**
IRQ=10 Serial Port I/O port address is 2D8h and the interrupt address is IRQ10
- ➔ **IO=2D0h;**
IRQ=10, 11 Serial Port I/O port address is 2D0h and the interrupt address is IRQ10, 11
- ➔ **IO=2D8h;**
IRQ=10, 11 Serial Port I/O port address is 2D8h and the interrupt address is IRQ10, 11

TANK-860-HM86 Embedded System

5.3.9 F81866 H/W Monitor

The **F8186 H/W Monitor** menu (**BIOS Menu 12**) shows the operating temperature, fan speeds and system voltages.

```

Aptio Setup Utility - Copyright (C) 2011 American Megatrends, Inc.
Advanced
PC Health Status
> Smart Fan Mode Configuration
CPU Temperature      :+86 C
System Temperature  :+58 C
CPU_FAN1 Speed      :N/A

Smart Fan Mode Select

-----
<=>: Select Screen
↑↓: Select Item
Enter>Select
+/-: Change Opt.
F1:  General Help
F2:  Previous Values
F3:  Optimized
Defaults
F4:  Save & Exit
ESC: Exit

Version 2.14.1219. Copyright (C) 2011 American Megatrends, Inc.

```

BIOS Menu 12: F81866 H/W Monitor

→ PC Health Status

The following system parameters and values are shown. The system parameters that are monitored are:

- System Temperatures:
 - CPU Temperature
 - System Temperature
- Fan Speeds:
 - CPU_Fan1 Speed

5.3.9.1 Smart Fan Mode Configuration

Use the **Smart Fan Mode Configuration** submenu (**BIOS Menu 13**) to configure the smart fan temperature and speed settings.

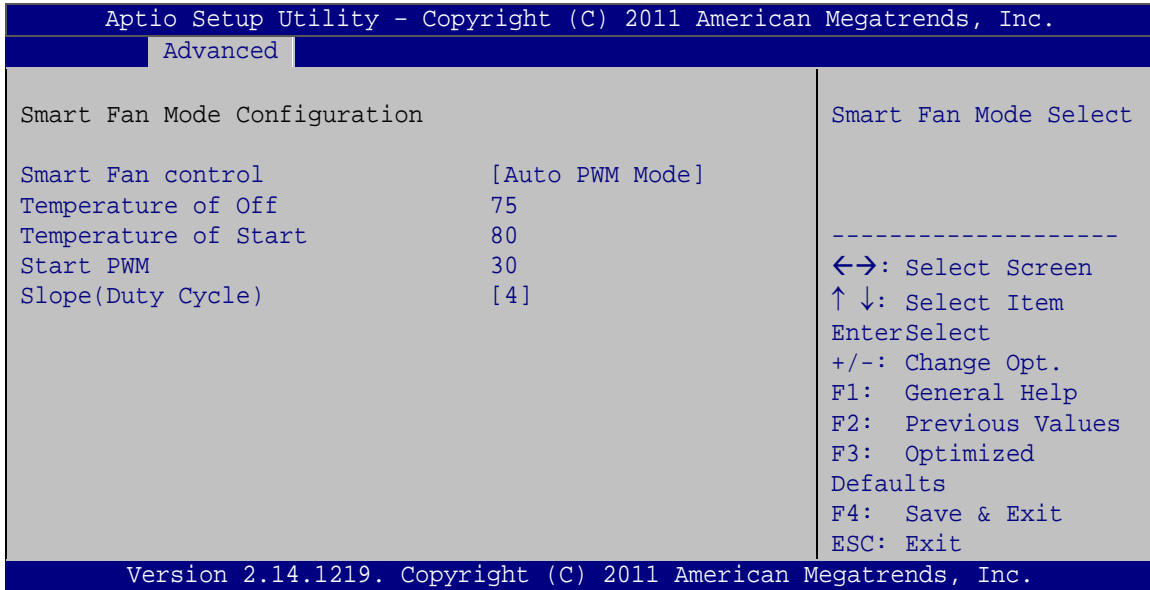

BIOS Menu 13: Smart Fan Mode Configuration

→ Smart Fan control [Auto PWM Mode]

Use the **Smart Fan control** BIOS option to configure the CPU Smart Fan.

- **Full Mode** Fan is on all the time
- **Manual PWM Mode** The fan spins at the speed set in the manual setting
- **Auto PWM Mode** **DEFAULT** The fan adjusts its speed using these settings:
 - Temperature of Start
 - Temperature of Off
 - Start PWM
 - Slope (Duty Cycle)

→ Temperature of Off [75]



WARNING:

Setting this value too high may cause the fan to speed up only when the CPU is at a very high temperature and therefore cause the system to be damaged.

The **Temperature of Off** option can only be set if the **Smart Fan control** option is set to **Auto PWM Mode**. When the **CPU Temperature** is lower than **Temperature of Off**, the fan will be rotate at lowest speed. To set a value, select the **Temperature of Off** option and enter a decimal number between 0 and 127. The temperature range is specified below.

- Minimum Value: 0°C
- Maximum Value: 127°C

→ Temperature of Start [80]



WARNING:

Setting this value too high may cause the fan to rotate at full speed only when the CPU is at a very high temperature and therefore cause the system to be damaged.

The **Temperature of Start** option can only be set if the **Smart Fan control** option is set to **Auto PWM Mode**. Use the **Temperature of Start** option to set the CPU temperature at which the cooling fan starts to rotate using the starting pulse width modulation (PWM) specified in the **Start PWM** option below. To set a value, select the **Temperature of Start** option and enter a decimal number between 0 and 127. The temperature range is specified below.

- Minimum Value: 0°C

- Maximum Value: 127°C

→ Start PWM [30]

The **Start PWM** option can only be set if the **Smart Fan control** option is set to **Auto PWM Mode**. Use the **Start PWM** option to set the PWM start value. To set a value, select the **Start PWM** option and enter a decimal number between 0 and 100. The temperature range is specified below.

- Minimum Value: 0
- Maximum Value: 100

→ Slope (Duty Cycle) [4 (PWM)]

The **Slope (Duty Cycle)** option can only be set if the **Smart Fan control** option is set to **Auto PWM Mode**. Use the **Slope (Duty Cycle)** option to select the linear rate at which the PWM mode increases with respect to an increase in temperature. A list of available options is shown below:

- 0
- 1
- 2
- 4
- 8
- 16

5.3.10 Serial Port Console Redirection

The **Serial Port Console Redirection** menu (**BIOS Menu 14**) allows the console redirection options to be configured. Console redirection allows users to maintain a system remotely by re-directing keyboard input and text output through the serial port.

```

Aptio Setup Utility - Copyright (C) 2011 American Megatrends, Inc.
  Advanced
COM1
  Console Redirection      [Disabled]
> Console Redirection Settings
COM2
  Console Redirection      [Disabled]
> Console Redirection Settings
COM3
  Console Redirection      [Disabled]
> Console Redirection Settings
COM4
  Console Redirection      [Disabled]
> Console Redirection Settings
COM5
  Console Redirection      [Disabled]
> Console Redirection Settings
COM6
  Console Redirection      [Disabled]
> Console Redirection Settings
COM7
  Console Redirection      [Disabled]
> Console Redirection Settings
COM8
  Console Redirection      [Disabled]
> Console Redirection Settings
IPMI (Disabled)
  Console Redirection
-----
<->: Select Screen
↑ ↓: Select Item
Enter>Select
+/-: Change Opt.
F1:  General Help
F2:  Previous Values
F3:  Optimized Defaults
F4:  Save & Exit
ESC: Exit
Version 2.14.1219. Copyright (C) 2011 American Megatrends, Inc.
  
```

BIOS Menu 14: Serial Port Console Redirection

➔ Console Redirection [Disabled]

Use **Console Redirection** option to enable or disable the console redirection function.

- ➔ **Disabled** **DEFAULT** Disabled the console redirection function
- ➔ **Enabled** Enabled the console redirection function

5.3.10.1 Console Redirection Settings

The **Console Redirection Settings** menu (**BIOS Menu 15**) allows the console redirection options to be configured. The option is active when Console Redirection option is enabled.

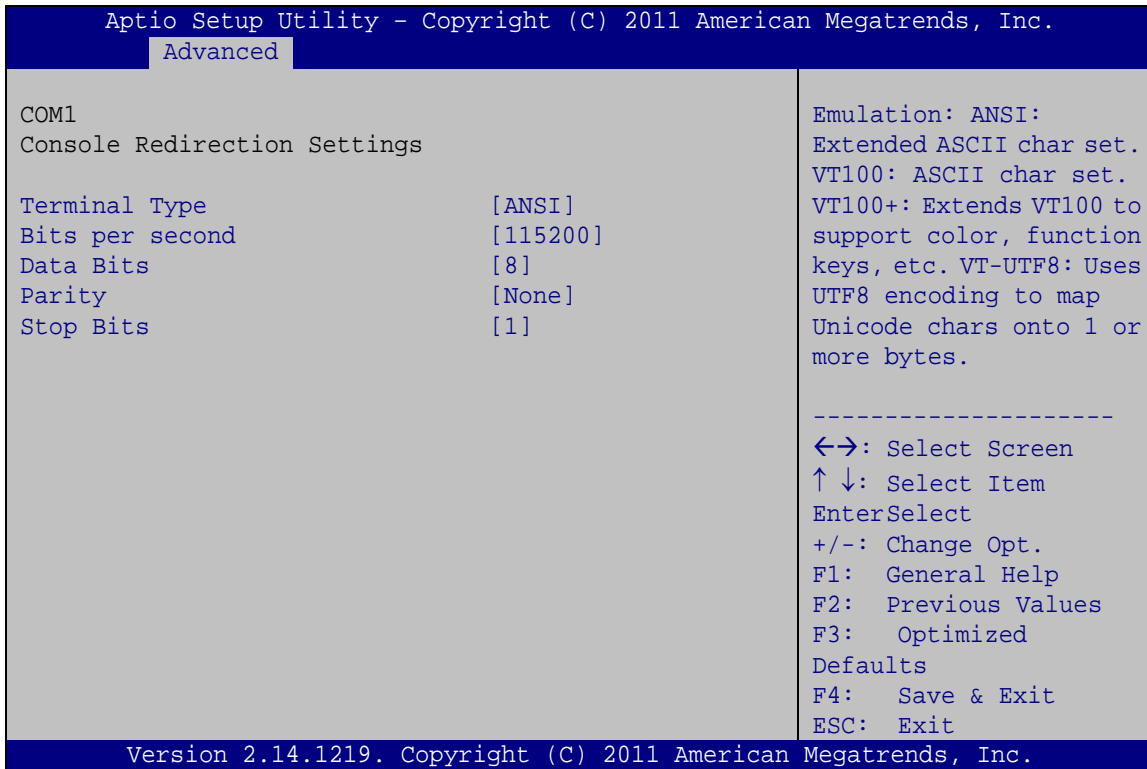

BIOS Menu 15: Console Redirection Settings

➔ Terminal Type [ANSI]

Use the **Terminal Type** option to specify the remote terminal type..

- ➔ **VT100** The target terminal type is VT100
- ➔ **VT100+** The target terminal type is VT100+
- ➔ **VT-UTF8** The target terminal type is VT-UTF8
- ➔ **ANSI** **DEFAULT** The target terminal type is ANSI

➔ Bits per second [115200]

Use the **Bits per second** option to specify the transmission speed of the serial port.

TANK-860-HM86 Embedded System

- **9600** The transmission speed is 9600
- **19200** The transmission speed is 19200
- **38400** The transmission speed is 38400
- **57600** The transmission speed is 57600
- **115200** **DEFAULT** The transmission speed is 115200

→ Data Bits [8]

Use the **Data Bits** option to specify the number of data bits.

- **7** Sets the data bits at 7.
- **8** **DEFAULT** Sets the data bits at 8.

→ Parity [None]

Use the **Parity** option to specify the parity bit that can be sent with the data bits for detecting the transmission errors.

- **None** **DEFAULT** No parity bit is sent with the data bits.
- **Even** The parity bit is 0 if the number of ones in the data bits is even.
- **Odd** The parity bit is 0 if the number of ones in the data bits is odd.
- **Mark** The parity bit is always 1. This option does not provide error detection.
- **Space** The parity bit is always 0. This option does not provide error detection.

→ Stop Bits [1]

Use the **Stop Bits** option to specify the number of stop bits used to indicate the end of a serial data packet. Communication with slow devices may require more than 1 stop bit.

- ➔ 1 **DEFAULT** Sets the number of stop bits at 1.
- ➔ 2 Sets the number of stop bits at 2.

5.3.11 iEi Feature

Use the **iEi Feature** menu (**BIOS Menu 16**) to configure the iEi features.

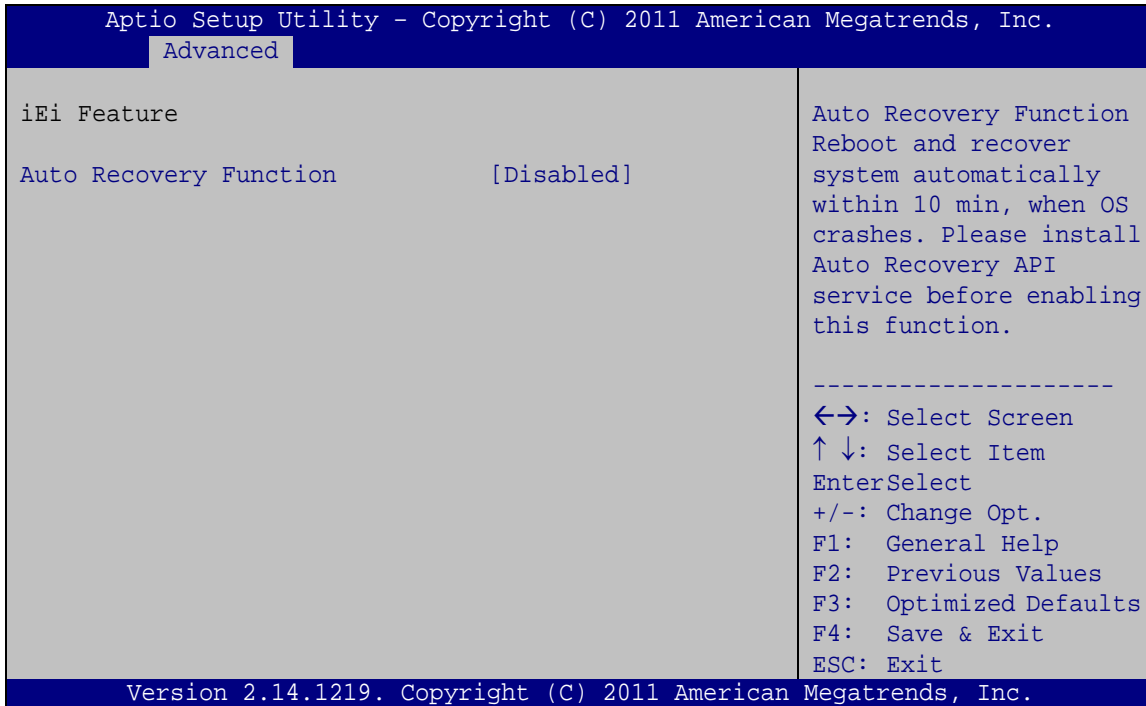

BIOS Menu 16: iEi Feature

- ➔ Auto Recovery Function [Disabled]

Use **Auto Recovery Function** option to enable or disable the auto recovery function.

- ➔ **Disabled** **DEFAULT** Disabled the auto recovery function
- ➔ **Enabled** Enabled the auto recovery function

5.4 Chipset

Use the **Chipset** menu (**BIOS Menu 17**) to access the PCH-IO and System Agent (SA) configuration menus.



WARNING!

Setting the wrong values for the Chipset BIOS selections in the Chipset BIOS menu may cause the system to malfunction.

```
Aptio Setup Utility - Copyright (C) 2011 American Megatrends, Inc.
Main   Advanced  Chipset  Boot   Security  Save & Exit
-----
> PCH-IO Configuration          PCH Parameters
> System Agent (SA) Configuration

-----
<=>: Select Screen
↑ ↓: Select Item
Enter>Select
+/-: Change Opt.
F1:  General Help
F2:  Previous Values
F3:  Optimized Defaults
F4:  Save & Exit
ESC: Exit

Version 2.14.1219. Copyright (C) 2011 American Megatrends, Inc.
```

BIOS Menu 17: Chipset

5.4.1 PCH-IO Configuration

Use the **PCH-IO Configuration** menu (**BIOS Menu 18**) to configure the PCH parameters.

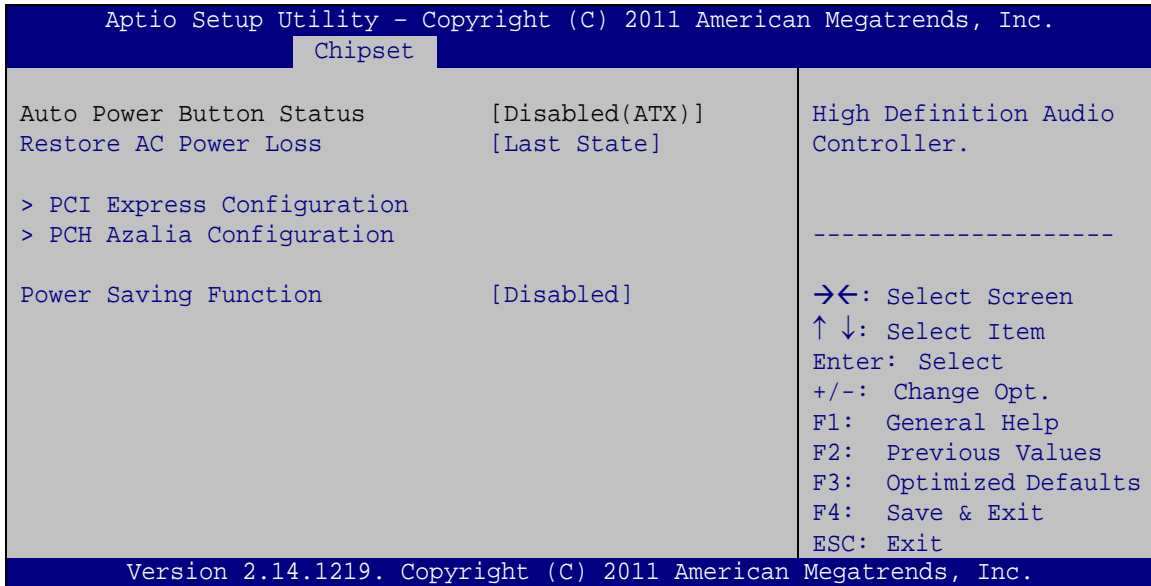

BIOS Menu 18: PCH-IO Configuration

→ Restore AC Power Loss [Last State]

Use the **Restore on AC Power Loss** option to specify what state the system returns to if there is a sudden loss of power to the system.

- **Power Off** The system remains turned off
- **Power On** The system turns on
- **Last State** **DEFAULT** The system returns to its previous state. If it was on, it turns itself on. If it was off, it remains off.

→ Power Saving Function [Disabled]

Use the **Power Saving Function** BIOS option to enable or disable the power saving function.

- **Disabled** **DEFAULT** Power saving function is disabled.
- **Enabled** Power saving function is enabled. It will reduce power consumption when the system is off.

TANK-860-HM86 Embedded System

5.4.1.1 PCI Express Configuration

Use the **PCI Express Configuration** menu (**BIOS Menu 19**) to select the support type of the PCIe Mini slot.

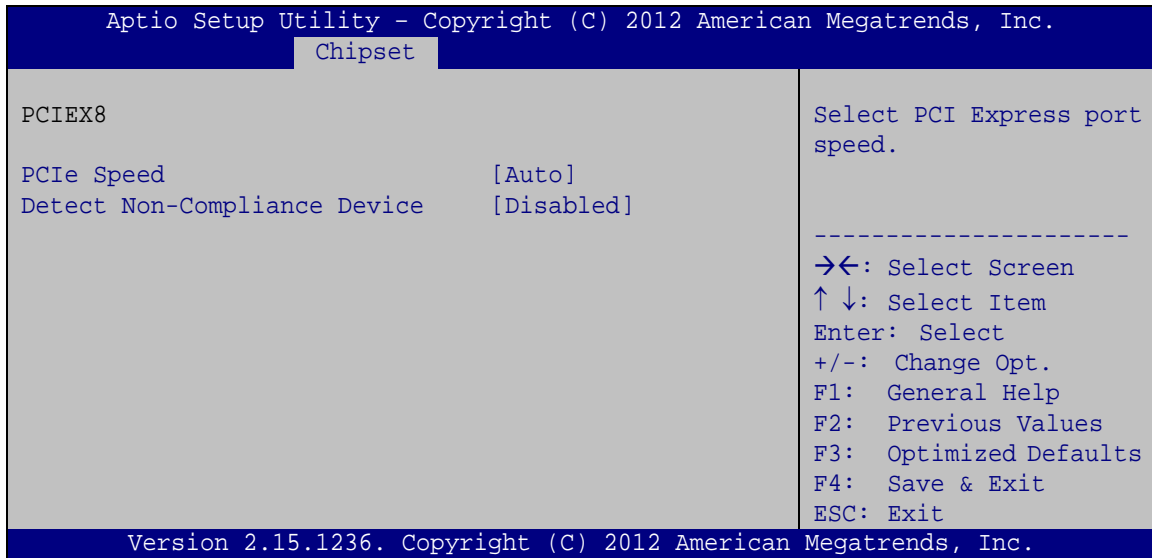

BIOS Menu 19: PCI Express Configuration

→ PCIe Speed

Use PCIe Speed option to select the speed type of the PCIe Mini slot. The following options are available:

- Auto **Default**
- Gen1
- Gen2

→ Detect Non-Compliance Device [Disabled]

Use the **Detect Non-Compliance Device** option to enable or disable the “detect no-compliance PCIe device” function.

- ➔ **Disabled** **DEFAULT** Detect no-compliance PCIe device function is disabled
- ➔ **Enabled** Detect no-compliance PCIe device function is enabled. If will take more time at POST if it is enabled.

5.4.1.2 PCH Azalia Configuration

Use the **PCH Azalia Configuration** menu (**BIOS Menu 20**) to configure the PCH Azalia settings.

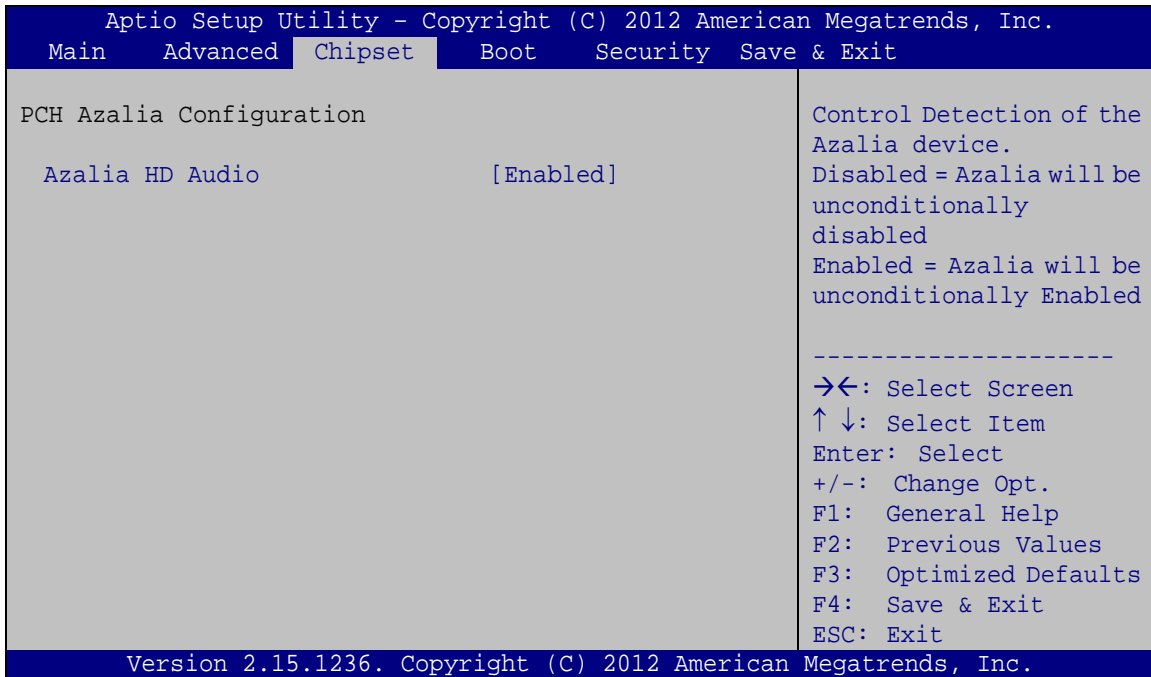

BIOS Menu 20: PCH Azalia Configuration Menu

➔ Azalia HD Audio [Enabled]

Use the **Azalia** option to enable or disable the High Definition Audio controller.

- ➔ **Disabled** The onboard High Definition Audio controller is disabled
- ➔ **Enabled DEFAULT** The onboard High Definition Audio controller automatically detected and enabled

5.4.2 System Agent (SA) Configuration

Use the **System Agent (SA) Configuration** menu (**BIOS Menu 21**) to configure the System Agent (SA) parameters.

TANK-860-HM86 Embedded System

```

Aptio Setup Utility - Copyright (C) 2012 American Megatrends, Inc.
Chipset
VT-d [Enabled] Check to enable VT-d function on MCH.
> Graphics Configuration
> NB PCIe Configuration
> Memory Configuration
-----
-><: Select Screen
↑↓: Select Item
Enter: Select
+/-: Change Opt.
F1: General Help
F2: Previous Values
F3: Optimized Defaults
F4: Save & Exit
ESC: Exit
Version 2.15.1236. Copyright (C) 2012 American Megatrends, Inc.

```

BIOS Menu 21: System Agent (SA) Configuration

5.4.2.1 Graphics Configuration

Use the **Graphics Configuration (BIOS Menu 22)** menu to configure the video device connected to the system.

```

Aptio Setup Utility - Copyright (C) 2012 American Megatrends, Inc.
Chipset
Graphics Configuration
Primary Display [Auto]
DVMT Pre-Allocated [256M]
DVMT Total Gfx Mem [MAX]
Primary IGFX Boot Display [VBIOS Default]
-----
Select which of IGFX/PEG/PCI Graphics device should be Primary Display Or select SG for Switchable Gfx.
-----
-><: Select Screen
↑↓: Select Item
Enter: Select
+/-: Change Opt.
F1: General Help
F2: Previous Values
F3: Optimized Defaults
F4: Save & Exit
ESC: Exit
Version 2.15.1236. Copyright (C) 2012 American Megatrends, Inc.

```

BIOS Menu 22: Graphics Configuration

→ Primary Display [Auto]

Use the **Primary Display** option to select the primary graphics controller the system uses.

The following options are available:

- Auto **Default**
- IGFX
- PEG
- PCIE

→ DVMT Pre-Allocated [256M]

Use the **DVMT Pre-Allocated** option to set the amount of system memory allocated to the integrated graphics processor when the system boots. The system memory allocated can then only be used as graphics memory, and is no longer available to applications or the operating system. Configuration options are listed below:

- 32M
- 64M
- 128M
- 256M **Default**
- 512M

→ DVMT Total Gfx Mem [MAX]

Use the **DVMT Total Gfx Mem** option to select DVMT5.0 total graphic memory size used by the internal graphic device. The following options are available:

- 128M
- 256M
- MAX **Default**

→ Primary IGFX Boot Display [VBIOS Default]

Use the **Primary IGFX Boot Display** option to select the display device used by the system when it boots. Configuration options are listed below.

- VBIOS Default **DEFAULT**
- CRT
- Display port 1

- DVI

5.4.2.2 NB PCIe Configuration

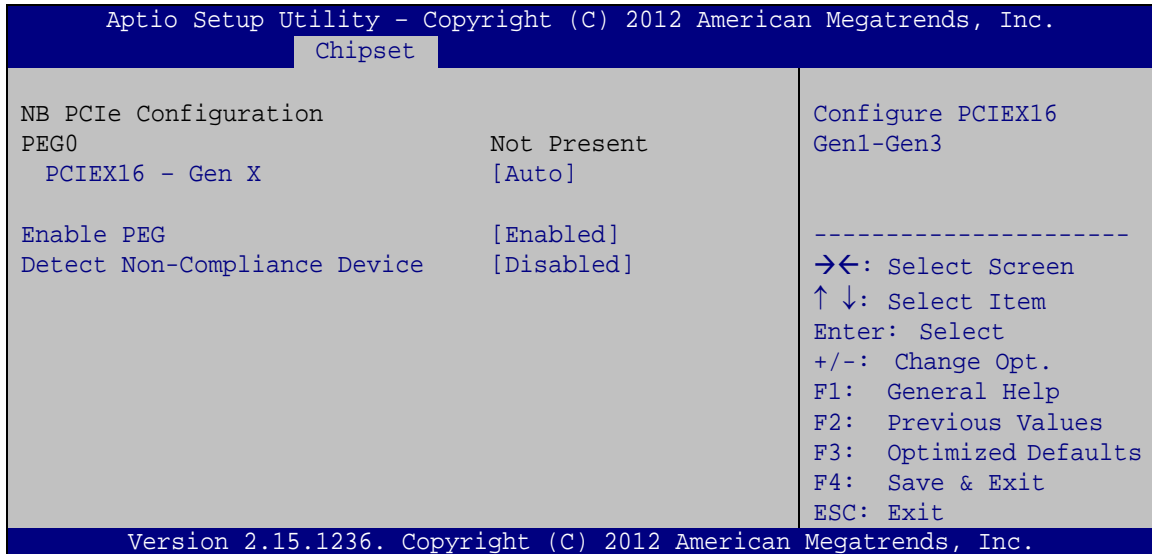

BIOS Menu 23: NB PCIe Configuration

→ PCIEX16 – Gen X [Auto]

Use the **PCIEX16 – Gen X** option to select the support type of the PCI Express x16 slot.

The following options are available:

- Auto **Default**
- Gen1
- Gen2
- Gen3

→ Enable PEG [Enabled]

Use the **Enable PEG** option to enable or disable the PCI Express controller. The following options are available:

- Disabled
- Enabled **Default**
- Auto

➔ Detect Non-Compliance Device [Disabled]

Use the **Detect Non-Compliance Device** option to enable or disable detecting a non-compliance PCI Express device in the PEG. The following options are available:

- Disabled **Default**
- Enabled

5.4.2.3 Memory Configuration

Use the **Memory Configuration** submenu (**BIOS Menu 24**) to view memory information.

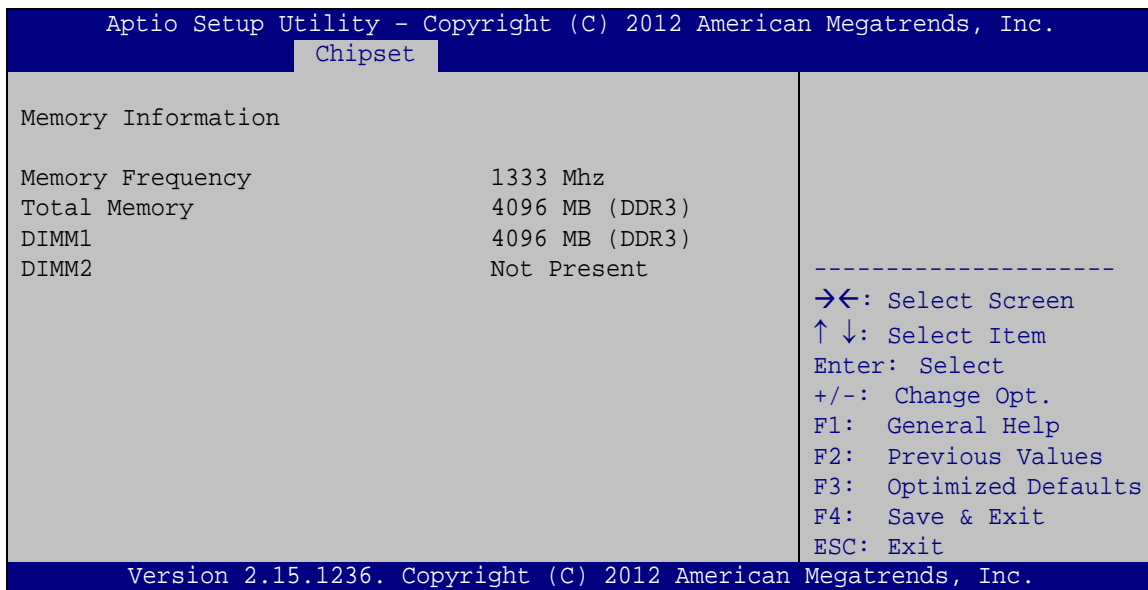

BIOS Menu 24: Memory Configuration

5.5 Boot

Use the **Boot** menu (**BIOS Menu 25**) to configure system boot options.

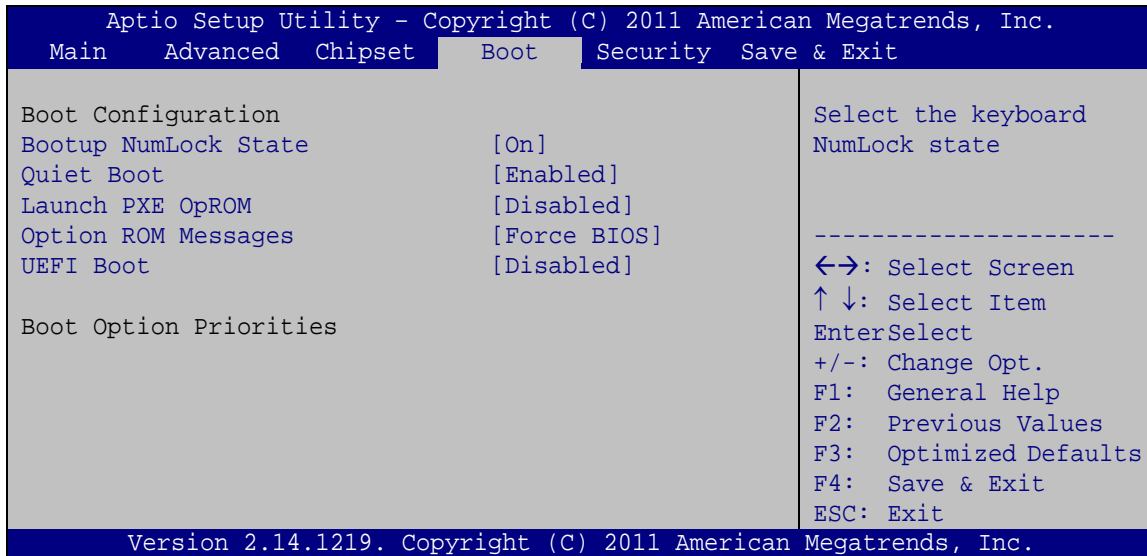

BIOS Menu 25: Boot

→ Bootup NumLock State [On]

Use the **Bootup NumLock State** BIOS option to specify if the number lock setting must be modified during boot up.

→ **On** **DEFAULT** Allows the Number Lock on the keyboard to be enabled automatically when the computer system boots up. This allows the immediate use of the 10-key numeric keypad located on the right side of the keyboard. To confirm this, the Number Lock LED light on the keyboard is lit.

→ **Off** Does not enable the keyboard Number Lock automatically. To use the 10-keys on the keyboard, press the Number Lock key located on the upper left-hand corner of the 10-key pad. The Number Lock LED on the keyboard lights up when the Number Lock is engaged.

→ Quiet Boot [Enabled]

Use the **Quiet Boot** BIOS option to select the screen display when the system boots.

- **Disabled** Normal POST messages displayed
- **Enabled** **DEFAULT** OEM Logo displayed instead of POST messages

→ Launch PXE OpROM [Disabled]

Use the **Launch PXE OpROM** option to enable or disable boot option for legacy network devices.

- **Disabled** **DEFAULT** Ignore all PXE Option ROMs
- **Enabled** Load PXE Option ROMs.

→ Option ROM Messages [Force BIOS]

Use the **Option ROM Messages** option to set the Option ROM display mode.

- **Force BIOS** **DEFAULT** Sets display mode to force BIOS.
- **Keep Current** Sets display mode to current.

→ UEFI Boot [Disabled]

Use the **UEFI Boot** option to enable or disable to boot from the UEFI devices.

- **Enabled** Boot from UEFI devices is enabled.
- **Disabled** **DEFAULT** Boot from UEFI devices is disabled.

5.6 Security

Use the **Security** menu (**BIOS Menu 26**) to set system and user passwords.

5.7 Exit

Use the **Exit** menu (**BIOS Menu 27**) to load default BIOS values, optimal failsafe values and to save configuration changes.

```
Aptio Setup Utility - Copyright (C) 2011 American Megatrends, Inc.
Main   Advanced  Chipset   Boot     Security  Save & Exit
-----
Save Changes and Reset
Discard Changes and Reset

Restore Defaults
Save as User Defaults
Restore User Defaults

Exit the system after
saving the changes.

-----
<->: Select Screen
↑ ↓: Select Item
Enter>Select
+/-: Change Opt.
F1:  General Help
F2:  Previous Values
F3:  Optimized Defaults
F4:  Save & Exit
ESC: Exit

Version 2.14.1219. Copyright (C) 2011 American Megatrends, Inc.
```

BIOS Menu 27:Exit

→ Save Changes and Reset

Use the **Save Changes and Reset** option to save the changes made to the BIOS options and reset the system.

→ Discard Changes and Reset

Use the **Discard Changes and Reset** option to exit the system without saving the changes made to the BIOS configuration setup program.

→ Restore Defaults

Use the **Restore Defaults** option to load the optimal default values for each of the parameters on the Setup menus. **F3 key can be used for this operation.**

TANK-860-HM86 Embedded System

➔ Save as User Defaults

Use the **Save as User Defaults** option to save the changes done so far as user defaults.

➔ Restore User Defaults

Use the **Restore User Defaults** option to restore the user defaults to all the setup options.

Appendix

A

Regulatory Compliance

DECLARATION OF CONFORMITY



This equipment is in conformity with the following EU directives:

- EMC Directive 2004/108/EC
- Low-Voltage Directive 2006/95/EC
- RoHS II Directive 2011/65/EU
- Ecodesign Directive 2009/125/EC

If the user modifies and/or install other devices in the equipment, the CE conformity declaration may no longer apply.

If this equipment has telecommunications functionality, it also complies with the requirements of the R&TTE Directive 1999/5/EC.

English

IEI Integration Corp declares that this equipment is in compliance with the essential requirements and other relevant provisions of Directive 1999/5/EC.

Български [Bulgarian]

IEI Integration Corp. декларира, че този оборудване е в съответствие със съществените изисквания и другите приложими правила на Директива 1999/5/EC.

Česky [Czech]

IEI Integration Corp tímto prohlašuje, že tento zařizení je ve shodě se základními požadavky a dalšími příslušnými ustanoveními směrnice 1999/5/ES.

Dansk [Danish]

IEI Integration Corp erklærer herved, at følgende udstyr overholder de væsentlige krav og øvrige relevante krav i direktiv 1999/5/EF.

Deutsch [German]

IEI Integration Corp, erklärt dieses Gerät entspricht den grundlegenden Anforderungen und den weiteren entsprechenden Vorgaben der Richtlinie 1999/5/EU.

Eesti [Estonian]

IEI Integration Corp deklareerib seadme seadme vastavust direktiivi 1999/5/EÜ põhinõuetele ja nimetatud direktiivist tulenevatele teistele asjakohastele sätetele.

Español [Spanish]

IEI Integration Corp declara que el equipo cumple con los requisitos esenciales y cualesquiera otras disposiciones aplicables o exigibles de la Directiva 1999/5/CE.

Ελληνική [Greek]

IEI Integration Corp ΔΗΛΩΝΕΙ ΟΤΙ ΕΞΟΠΛΙΣΜΟΣ ΣΥΜΜΟΡΦΩΝΕΤΑΙ ΠΡΟΣ ΤΙΣ ΟΥΣΙΩΔΕΙΣ ΑΠΑΙΤΗΣΕΙΣ ΚΑΙ ΤΙΣ ΛΟΙΠΕΣ ΣΧΕΤΙΚΕΣ ΔΙΑΤΑΞΕΙΣ ΤΗΣ ΟΔΗΓΙΑΣ 1999/5/EK.

Français [French]

IEI Integration Corp déclare que l'appareil est conforme aux exigences essentielles et aux autres dispositions pertinentes de la directive 1999/5/CE.

Italiano [Italian]

IEI Integration Corp dichiara che questo apparecchio è conforme ai requisiti essenziali ed alle altre disposizioni pertinenti stabilite dalla direttiva 1999/5/CE.

Latviski [Latvian]

IEI Integration Corp deklarē, ka iekārta atbilst būtiskajām prasībām un citiem ar to saistītajiem noteikumiem Direktīvas 1999/5/EK.

Lietuvių [Lithuanian]

IEI Integration Corp deklaruoja, kad šis įranga atitinka esminius reikalavimus ir kitas 1999/5/EB Direktyvos nuostatas.

Nederlands [Dutch]

IEI Integration Corp dat het toestel toestel in overeenstemming is met de essentiële eisen en de andere relevante bepalingen van richtlijn 1999/5/EG.

Malti [Maltese]

IEI Integration Corp jiddikjara li dan prodott jikkonforma mal-ħtiġijiet essenzjali u ma provvedimenti oħrajn relevanti li hemm fid-Dirrettiva 1999/5/EC.

TANK-860-HM86 Embedded System

Magyar [Hungarian]

IEI Integration Corp nyilatkozom, hogy a berendezés megfelel a vonatkozó alapvető követelményeknek és az 1999/5/EC irányelv egyéb előírásainak.

Polski [Polish]

IEI Integration Corp oświadcza, że wyrobu jest zgodny z zasadniczymi wymogami oraz pozostałymi stosownymi postanowieniami Dyrektywy 1999/5/EC.

Português [Portuguese]

IEI Integration Corp declara que este equipamento está conforme com os requisitos essenciais e outras disposições da Directiva 1999/5/CE.

Româna [Romanian]

IEI Integration Corp declară că acest echipament este în conformitate cu cerințele esențiale și cu celelalte prevederi relevante ale Directivei 1999/5/CE.

Slovensko [Slovenian]

IEI Integration Corp izjavlja, da je ta opreme v skladu z bistvenimi zahtevami in ostalimi relevantnimi določili direktive 1999/5/ES.

Slovensky [Slovak]

IEI Integration Corp týmto vyhlasuje, že zariadenia spĺňa základné požiadavky a všetky príslušné ustanovenia Smernice 1999/5/ES.

Suomi [Finnish]

IEI Integration Corp vakuuttaa täten että laitteet on direktiivin 1999/5/EY oleellisten vaatimusten ja sitä koskevien direktiivin muiden ehtojen mukainen.

Svenska [Swedish]

IEI Integration Corp förklarar att denna utrustningstyp står i överensstämmelse med de väsentliga egenskapskrav och övriga relevanta bestämmelser som framgår av direktiv 1999/5/EG.

FCC WARNING



This equipment complies with Part 15 of the FCC Rules. Operation is subject to the following two conditions:

- This device may not cause harmful interference, and
- This device must accept any interference received, including interference that may cause undesired operation.

This equipment has been tested and found to comply with the limits for a Class A digital device, pursuant to part 15 of the FCC Rules. These limits are designed to provide reasonable protection against harmful interference when the equipment is operated in a commercial environment. This equipment generates, uses, and can radiate radio frequency energy and, if not installed and used in accordance with the instruction manual, may cause harmful interference to radio communications. Operation of this equipment in a residential area is likely to cause harmful interference in which case the user will be required to correct the interference at his own expense.

Appendix

B

Safety Precautions

B.1 Safety Precautions



WARNING:

The precautions outlined in this appendix should be strictly followed. Failure to follow these precautions may result in permanent damage to the TANK-860-HM86 Series.

Please follow the safety precautions outlined in the sections that follow:

B.1.1 General Safety Precautions

Please ensure the following safety precautions are adhered to at all times.

- ***Make sure the power is turned off and the power cord is disconnected*** when moving, installing or modifying the system.
- ***Do not apply voltage levels that exceed the specified voltage range.*** Doing so may cause fire and/or an electrical shock.
- ***Electric shocks can occur*** if opened while still powered on.
- ***Do not drop or insert any objects*** into the ventilation openings.
- ***If considerable amounts of dust, water, or fluids enter the system***, turn off the power supply immediately, unplug the power cord, and contact the system vendor.
- **DO NOT:**
 - Drop the system against a hard surface.
 - In a site where the ambient temperature exceeds the rated temperature

TANK-860-HM86 Embedded System

B.1.2 Anti-static Precautions

**WARNING:**

Failure to take ESD precautions during the installation of the TANK-860-HM86 Series may result in permanent damage to the TANK-860-HM86 Series and severe injury to the user.

Electrostatic discharge (ESD) can cause serious damage to electronic components, including the TANK-860-HM86 Series. Dry climates are especially susceptible to ESD. It is therefore critical that whenever the TANK-860-HM86 Series is opened and any of the electrical components are handled, the following anti-static precautions are strictly adhered to.

- ***Wear an anti-static wristband:*** Wearing a simple anti-static wristband can help to prevent ESD from damaging any electrical component.
- ***Self-grounding:*** Before handling any electrical component, touch any grounded conducting material. During the time the electrical component is handled, frequently touch any conducting materials that are connected to the ground.
- ***Use an anti-static pad:*** When configuring or working with an electrical component, place it on an anti-static pad. This reduces the possibility of ESD damage.
- ***Only handle the edges of the electrical component:*** When handling the electrical component, hold the electrical component by its edges.

B.1.3 Product Disposal

**CAUTION:**

Risk of explosion if battery is replaced by an incorrect type. Only certified engineers should replace the on-board battery.

Dispose of used batteries according to instructions and local regulations.

- Outside the European Union - If you wish to dispose of used electrical and electronic products outside the European Union, please contact your local authority so as to comply with the correct disposal method.
- Within the European Union:

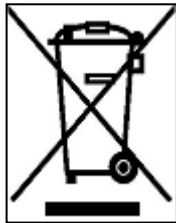

EU-wide legislation, as implemented in each Member State, requires that waste electrical and electronic products carrying the mark (left) must be disposed of separately from normal household waste. This includes monitors and electrical accessories, such as signal cables or power cords.

When you need to dispose of your display products, please follow the guidance of your local authority, or ask the shop where you purchased the product. The mark on electrical and electronic products only applies to the current European Union Member States.

Please follow the national guidelines for electrical and electronic product disposal.

B.2 Maintenance and Cleaning Precautions

When maintaining or cleaning the TANK-860-HM86 Series, please follow the guidelines below.

B.2.1 Maintenance and Cleaning

Prior to cleaning any part or component of the TANK-860-HM86 Series, please read the details below.

TANK-860-HM86 Embedded System

- The interior of the TANK-860-HM86 Series does not require cleaning. Keep fluids away from the TANK-860-HM86 Series interior.
- Be cautious of all small removable components when vacuuming the TANK-860-HM86 Series.
- Turn the TANK-860-HM86 Series off before cleaning the TANK-860-HM86 Series.
- Never drop any objects or liquids through the openings of the TANK-860-HM86 Series.
- Be cautious of any possible allergic reactions to solvents or chemicals used when cleaning the TANK-860-HM86 Series.
- Avoid eating, drinking and smoking within vicinity of the TANK-860-HM86 Series.

B.2.2 Cleaning Tools

Some components in the TANK-860-HM86 Series may only be cleaned using a product specifically designed for the purpose. In such case, the product will be explicitly mentioned in the cleaning tips. Below is a list of items to use when cleaning the TANK-860-HM86 Series.

- **Cloth** – Although paper towels or tissues can be used, a soft, clean piece of cloth is recommended when cleaning the TANK-860-HM86 Series.
- **Water or rubbing alcohol** – A cloth moistened with water or rubbing alcohol can be used to clean the TANK-860-HM86 Series.
- **Using solvents** – The use of solvents is not recommended when cleaning the TANK-860-HM86 Series as they may damage the plastic parts.
- **Vacuum cleaner** – Using a vacuum specifically designed for computers is one of the best methods of cleaning the TANK-860-HM86 Series. Dust and dirt can restrict the airflow in the TANK-860-HM86 Series and cause its circuitry to corrode.
- **Cotton swabs** - Cotton swabs moistened with rubbing alcohol or water are excellent tools for wiping hard to reach areas.
- **Foam swabs** - Whenever possible, it is best to use lint free swabs such as foam swabs for cleaning.

Appendix

C

Digital I/O Interface

C.1 Introduction

The DIO connector on the TANK-860-HM86 Series is interfaced to GPIO ports on the Super I/O chipset. The DIO has both 4-bit digital inputs and 4-bit digital outputs. The digital inputs and digital outputs are generally control signals that control the on/off circuit of external devices or TTL devices. Data can be read or written to the selected address to enable the DIO functions.



NOTE:

For further information, please refer to the datasheet for the Super I/O chipset.

The BIOS interrupt call **INT 15H** controls the digital I/O.

INT 15H:

AH – 6FH
<u>Sub-function:</u>
AL – 8 : Set the digital port as INPUT
AL : Digital I/O input value

C.2 Assembly Language Sample 1

```

MOV    AX, 6F08H    ;setting the digital port as input
INT    15H          ;
    
```

AL low byte = value

AH – 6FH
<u>Sub-function:</u>
AL – 9 : Set the digital port as OUTPUT
BL : Digital I/O input value

C.3 Assembly Language Sample 2

```

MOV    AX, 6F09H    ;setting the digital port as output
MOV    BL, 09H      ;digital value is 09H
INT    15H          ;
    
```

Digital Output is 1001b

Appendix

D

Hazardous Materials Disclosure

D.1 Hazardous Materials Disclosure Table for IPB Products Certified as RoHS Compliant Under 2002/95/EC Without Mercury

The details provided in this appendix are to ensure that the product is compliant with the Peoples Republic of China (China) RoHS standards. The table below acknowledges the presences of small quantities of certain materials in the product, and is applicable to China RoHS only.

A label will be placed on each product to indicate the estimated “Environmentally Friendly Use Period” (EFUP). This is an estimate of the number of years that these substances would “not leak out or undergo abrupt change.” This product may contain replaceable sub-assemblies/components which have a shorter EFUP such as batteries and lamps. These components will be separately marked.

Please refer to the table on the next page.

TANK-860-HM86 Embedded System

Part Name	Toxic or Hazardous Substances and Elements					
	Lead (Pb)	Mercury (Hg)	Cadmium (Cd)	Hexavalent Chromium (CR(VI))	Polybrominated Biphenyls (PBB)	Polybrominated Diphenyl Ethers (PBDE)
Housing	O	O	O	O	O	O
Display	O	O	O	O	O	O
Printed Circuit Board	O	O	O	O	O	O
Metal Fasteners	O	O	O	O	O	O
Cable Assembly	O	O	O	O	O	O
Fan Assembly	O	O	O	O	O	O
Power Supply Assemblies	O	O	O	O	O	O
Battery	O	O	O	O	O	O

O: This toxic or hazardous substance is contained in all of the homogeneous materials for the part is below the limit requirement in SJ/T11363-2006

X: This toxic or hazardous substance is contained in at least one of the homogeneous materials for this part is above the limit requirement in SJ/T11363-2006

此附件旨在确保本产品符合中国 RoHS 标准。以下表格标示此产品中某有毒物质的含量符合中国 RoHS 标准规定的限量要求。

本产品上会附有“环境友好使用期限”的标签，此期限是估算这些物质“不会有泄漏或突变”的年限。本产品可能包含有较短的环境友好使用期限的可替换元件，像是电池或灯管，这些元件将会单独标示出来。

部件名称	有毒有害物质或元素					
	铅 (Pb)	汞 (Hg)	镉 (Cd)	六价铬 (CR(VI))	多溴联苯 (PBB)	多溴二苯 醚 (PBDE)
壳体	O	O	O	O	O	O
显示	O	O	O	O	O	O
印刷电路板	O	O	O	O	O	O
金属螺帽	O	O	O	O	O	O
电缆组装	O	O	O	O	O	O
风扇组装	O	O	O	O	O	O
电力供应组装	O	O	O	O	O	O
电池	O	O	O	O	O	O

O: 表示该有毒有害物质在该部件所有物质材料中的含量均在 SJ/T11363-2006 标准规定的限量要求以下。
X: 表示该有毒有害物质至少在该部件的某一均质材料中的含量超出 SJ/T11363-2006 标准规定的限量要求。