



MODEL:
PPC-37xx-N270

**Panel PC with Touch Screen and Intel® Atom™ CPU
Gigabit Ethernet, Two USB, Audio, RS-232/422/485, SATA
RoHS Compliant, IP 65 Protection**

User Manual

Revision

Date	Version	Changes
12 March, 2014	2.21	Modified Appendix D: Hazardous Materials Disclosure
16 October, 2013	2.20	Updated for R22 version – added Section 6.7: Touchscreen Driver Installation
18 January, 2013	2.11	Deleted PPC-3712BA-N270 model information
26 March, 2012	2.10	Updated for R21 version
9 November, 2010	2.00	Updated for R20 version
15 October, 2009	1.03	Updated dimension drawings in Section 2.1
26 June, 2009	1.02	Added PPC-3712B-N270 dimension drawing and power supply specifications.
13 April, 2009	1.01	Added PPC-3712B-N270 series information
4 February, 2009	1.00	Initial release

Copyright

COPYRIGHT NOTICE

The information in this document is subject to change without prior notice in order to improve reliability, design and function and does not represent a commitment on the part of the manufacturer.

In no event will the manufacturer be liable for direct, indirect, special, incidental, or consequential damages arising out of the use or inability to use the product or documentation, even if advised of the possibility of such damages.

This document contains proprietary information protected by copyright. All rights are reserved. No part of this manual may be reproduced by any mechanical, electronic, or other means in any form without prior written permission of the manufacturer.

TRADEMARKS

All registered trademarks and product names mentioned herein are used for identification purposes only and may be trademarks and/or registered trademarks of their respective owners.

Table of Contents

1 INTRODUCTION.....	1
1.1 OVERVIEW.....	2
1.1.1 Features	3
1.1.2 Model Variations	3
1.1.3 Applications	4
1.2 EXTERNAL OVERVIEW.....	4
1.2.1 Front Panel	4
1.2.2 Rear Panel	5
1.2.3 Bottom Panel.....	5
1.2.4 Side Panel	7
1.2.5 Frame.....	7
1.3 SPECIFICATIONS	8
2 DETAILED SPECIFICATIONS	10
2.1 DIMENSIONS.....	11
2.1.1 PPC-3708A-N270 Dimensions	11
2.1.2 PPC-3710A-N270 Dimensions	12
2.1.3 PPC-3712A-N270 Dimensions	13
2.2 INTEL® ATOM™ PROCESSOR.....	14
2.3 MOTHERBOARD COMPONENTS.....	14
2.3.1 Memory Support.....	14
2.3.1.1 Installed Memory	14
2.3.1.2 Additional Memory.....	15
2.3.2 Storage Capacity.....	15
2.4 EXTERNAL PERIPHERAL INTERFACE CONNECTORS.....	16
2.4.1 Serial Port Connectors	16
2.4.2 LAN Connectivity.....	17
2.4.3 External USB Connectors.....	17
2.4.4 Keyboard and Mouse Connectivity.....	18
2.5 PPC-37XX-N270 FRONT SIDE.....	19
2.5.1 Monitor	19

PPC-37xx-N270 Panel PC

2.5.2 Touch-Screen Module.....	19
2.6 GRAPHICS	19
2.6.1 Intel® 945GSE Integrated Graphics Engine	19
2.6.2 Dual-Display.....	20
2.7 AUDIO	20
2.8 SYSTEM POWER	21
3 UNPACKING	22
3.1 UNPACKING.....	23
3.1.1 Packing List	24
4 INSTALLATION	27
4.1 ANTI-STATIC PRECAUTIONS	28
4.2 INSTALLATION PRECAUTIONS	28
4.3 PREINSTALLED COMPONENTS.....	29
4.4 INSTALLATION AND CONFIGURATION STEPS	29
4.5 REMOVE THE BACK COVER.....	30
4.5.1 PPC-3708 Back Cover Removal.....	30
4.5.2 PPC-3710 Back Cover Removal.....	30
4.5.3 PPC-3712 Back Cover Removal.....	31
4.6 JUMPER SETTINGS	31
4.7 COMPACTFLASH® CARD INSTALLATION	31
4.8 HDD INSTALLATION.....	32
4.8.1 PPC-3708 HDD Installation.....	32
4.8.2 PPC-3710 HDD Installation.....	34
4.8.3 PPC-3712 HDD Installation.....	35
4.9 CD DRIVE INSTALLATION (PPC-3712A-N270 ONLY).....	37
4.10 JUMPER SETTINGS	39
4.10.1 Access the Jumpers	39
4.10.2 Preconfigured Jumpers	40
4.10.3 AT Power Select Jumper Settings.....	40
4.10.4 CF Card Setup	41
4.10.5 Clear CMOS Jumper.....	42
4.10.6 COM 2 Function Select Jumper.....	43
4.10.6.1 COM2 RS-422 and RS-485 Pinouts	44

4.11 MOUNTING THE SYSTEM	45
4.11.1 Wall Mounting	45
4.11.2 Panel Mounting	48
4.11.2.1 PPC-3708A-N270 and PPC-3710A-N270	48
4.11.2.2 PPC-3712A-N270	50
4.11.3 Arm Mounting	52
4.11.4 Cabinet and Rack Installation	54
4.11.4.1 PPC-3708A-N270	54
4.11.4.2 PPC-3710A-N270 and PPC-3712A-N270	56
4.12 REAR PANEL CONNECTORS	57
4.12.1 Keyboard and Mouse Connection	57
4.12.2 LAN Connection	57
4.12.3 Serial Device Connection	58
4.12.4 USB Device Connection	59
4.12.5 VGA Monitor Connection	60
4.13 SYSTEM MAINTENANCE	61
5 BIOS SCREENS.....	62
5.1 INTRODUCTION.....	63
5.1.1 Starting Setup.....	63
5.1.2 Using Setup	63
5.1.3 Getting Help.....	64
5.1.4 Unable to Reboot After Configuration Changes.....	64
5.1.5 BIOS Menu Bar.....	64
5.2 MAIN.....	65
5.3 ADVANCED	66
5.3.1 CPU Configuration.....	67
5.3.2 IDE Configuration	68
5.3.2.1 IDE Master, IDE Slave	70
5.3.3 Super IO Configuration	75
5.3.4 Hardware Health Configuration.....	79
5.3.5 Power Configuration.....	83
5.3.5.1 ACPI configuration	84
5.3.5.2 APM Configuration.....	85
5.3.6 Remote Configuration	87

PPC-37xx-N270 Panel PC

5.3.7 USB Configuration.....	91
5.4 PCI/PNP.....	93
5.5 BOOT.....	96
5.5.1 Boot Settings Configuration.....	96
5.5.2 Boot Device Priority	99
5.6 SECURITY.....	100
5.7 CHIPSET	101
5.7.1 North Bridge Chipset Configuration	102
5.7.2 SouthBridge Configuration.....	105
5.8 EXIT	106
6 DRIVER INSTALLATION.....	108
6.1 AVAILABLE SOFTWARE DRIVERS	109
6.2 DRIVER CD AUTO-RUN	109
6.3 CHIPSET DRIVER INSTALLATION.....	110
6.4 INTEL [®] GRAPHICS MEDIA ACCELERATOR DRIVER	114
6.5 REALTEK LAN DRIVER INSTALLATION	120
6.6 REALTEK AC`97 AUDIO DRIVER (ALC655) INSTALLATION.....	122
6.6.1 BIOS Setup.....	122
6.6.2 Driver Installation	122
6.7 TOUCHSCREEN DRIVER INSTALLATION.....	126
6.7.1 Calibrating the Touchscreen	130
A SAFETY PRECAUTIONS	133
A.1 SAFETY PRECAUTIONS	134
A.1.1 General Safety Precautions.....	134
A.1.2 Anti-static Precautions	135
A.1.3 Product Disposal.....	136
A.2 MAINTENANCE AND CLEANING PRECAUTIONS	136
A.2.1 Maintenance and Cleaning.....	136
A.2.2 Cleaning Tools.....	137
B BIOS OPTIONS	138
C WATCHDOG TIMER	142
D HAZARDOUS MATERIALS DISCLOSURE	145

D.1 HAZARDOUS MATERIALS DISCLOSURE TABLE FOR IPB PRODUCTS CERTIFIED AS
ROHS COMPLIANT UNDER 2002/95/EC WITHOUT MERCURY 146

List of Figures

Figure 1-1: PPC-37xx-N270 Panel PC	2
Figure 1-2: Front View	4
Figure 1-3: PPC-3712A-N270 Wall-Mounting Bracket Retention Screw Holes.....	5
Figure 1-4: PPC-3708A-N270 Bottom View	6
Figure 1-5: PPC-3710A-N270 Bottom View	6
Figure 1-6: PPC-3712A-N270 Bottom View	6
Figure 1-7: PPC-3712A-N270 Left View	7
Figure 1-8: PPC-3712 Frame Rear View.....	7
Figure 2-1: PPC-3708A-N270 Dimensions (units in mm).....	11
Figure 2-2: PPC-3710A-N270 Dimensions (units in mm).....	12
Figure 2-3: PPC-3712A-N270 Dimensions (units in mm).....	13
Figure 2-4: PPC-3708A SATA Hard Disk Drive Bay.....	15
Figure 2-5: PPC-3708A CompactFlash® Slot.....	15
Figure 2-6: PPC-3708A COM Ports	16
Figure 2-7: PPC-3708A RJ-45 Ethernet Connectors	17
Figure 2-8: PPC-3708A External USB Ports.....	18
Figure 2-9: PPC-3708A PS/2 Connector	18
Figure 2-10: LCD Screen.....	19
Figure 2-11: PPC-3708A VGA Connector	20
Figure 2-12: PPC-3708A Audio Jack.....	20
Figure 2-13: Power Connector	21
Figure 4-1: PPC-3708 Back Cover Retention Screws	30
Figure 4-2: PPC-3710 Back Cover Retention Screws	30
Figure 4-3: PPC-3712 Back Cover Retention Screws	31
Figure 4-4: CF Card Installation	32
Figure 4-5: PPC-3708 HDD Bracket Retention Screws (Tope Panel)	33
Figure 4-6: PPC-3708 HDD Bracket Retention Screws (Inside)	33
Figure 4-7: PPC-3708 HDD Retention Screws	33
Figure 4-8: PPC-3710 HDD Bracket Retention Screws	34
Figure 4-9: PPC-3710 HDD Retention Screws	35

Figure 4-10: PPC-3712 HDD Bracket Retention Screws	36
Figure 4-11: PPC-3712 HDD Retention Screws	36
Figure 4-12: PPC-3712A CD Drive Bracket	37
Figure 4-13: CD Drive Cover Bracket Retention Screws	38
Figure 4-14: Jumper Locations	39
Figure 4-15: AT Power Select Jumper Location	41
Figure 4-16: CF Card Setup Jumper Location	42
Figure 4-17: Clear CMOS Jumper	43
Figure 4-18: COM 2 Function Select Jumper Location	44
Figure 4-19: Wall-mounting Bracket	46
Figure 4-20: Mount the Chassis	47
Figure 4-21: Secure the Chassis	48
Figure 4-22: Suggested Panel Cut Out Size for PPC-3708A-N270	49
Figure 4-23: Suggested Panel Cut Out Size for PPC-3710A-N270	49
Figure 4-24: Tighten the Panel Mounting Clamp Screws	50
Figure 4-25: PPC-3712 Panel Mounting Kit	50
Figure 4-26: Suggested Panel Cut Out Size for PPC-3712A-N270	51
Figure 4-27: Tighten the Panel Mounting Clamp Screws	52
Figure 4-28: Arm Mounting Retention Screw Holes	53
Figure 4-29: Arm Mounting	53
Figure 4-30: The Rack/Cabinet Bracket	54
Figure 4-31: Secure the PPC-3708A-N270 Rack/Cabinet Bracket	55
Figure 4-32: Install into a Rack/Cabinet	55
Figure 4-33: Secure the Rack/Cabinet Bracket	57
Figure 4-34: LAN Connection	58
Figure 4-35: Serial Device Connector	59
Figure 4-36: USB Device Connection	60
Figure 4-37: VGA Connector	61
Figure 6-1: Available Drivers	110
Figure 6-2: Chipset Driver Installation Program	111
Figure 6-3: Chipset Driver Welcome Screen	111
Figure 6-4: Chipset Driver License Agreement	112
Figure 6-5: Chipset Driver Read Me File	113
Figure 6-6: Chipset Driver Setup Operations	113
Figure 6-7: Chipset Driver Installation Finish Screen	114

PPC-37xx-N270 Panel PC

Figure 6-8: Select the Operating System	115
Figure 6-9: VGA Driver	115
Figure 6-10: GMA Driver Readme File	116
Figure 6-11: GMA Driver File Extraction	116
Figure 6-12: VGA Driver Welcome Screen	117
Figure 6-13: VGA Driver License Agreement.....	117
Figure 6-14: VGA Driver Read Me File.....	118
Figure 6-15: VGA Driver Setup Operations	119
Figure 6-16: VGA Driver Installation Finish Screen	119
Figure 6-17: LAN Driver Welcome Screen	120
Figure 6-18: LAN Driver Welcome Screen	121
Figure 6-19: LAN Driver Installation	121
Figure 6-20: LAN Driver Installation Complete.....	122
Figure 6-21: Select the Audio CODEC.....	123
Figure 6-22: AC`97 Audio Driver Install Shield Wizard Starting	123
Figure 6-23: AC`97 Audio Driver Setup Preparation	124
Figure 6-24: AC`97 Audio Driver Welcome Screen	124
Figure 6-25: AC`97 Audio Driver Digital Signal	125
Figure 6-26: AC`97 Audio Driver Installation Begins	125
Figure 6-27: AC`97 Audio Driver Installation Complete.....	126
Figure 6-28: Welcome Screen	127
Figure 6-29: Touchscreen Driver License Agreement.....	127
Figure 6-30: Choose Destination Folder	128
Figure 6-31: Setup Status	129
Figure 6-32: Touchscreen Driver Installation Finish Screen	129
Figure 6-33: Select Control Panel	130
Figure 6-34: Touchscreen Control Panel	130
Figure 6-35: Select Calibration Type	131
Figure 6-36: Calibration Window.....	132

List of Tables

Table 1-1: Model Variations	3
Table 1-2: System Specifications.....	9
Table 4-1: Jumpers	39
Table 4-2: Preconfigured Jumpers	40
Table 4-3: AT Power Select Jumper Settings	41
Table 4-4: CF Card Setup Jumper Settings	41
Table 4-5: Clear CMOS Jumper Settings.....	43
Table 4-6: COM 2 Function Select Jumper Settings	44
Table 4-7: RS-422 Pinouts	44
Table 4-8: RS-485 Pinouts	44
Table 5-1: BIOS Navigation Keys	64

BIOS Menus

Menu 1: Main	65
Menu 2: Advanced	67
Menu 3: CPU Configuration	68
Menu 4: IDE Configuration	69
Menu 5: IDE Master and IDE Slave Configuration	71
Menu 6: Super IO Configuration	76
Menu 7: Hardware Health Configuration	80
Menu 8: Power Configuration	83
Menu 9: ACPI Configuration	84
Menu 10: Advanced Power Management Configuration	85
Menu 11: Remote Access Configuration [Advanced]	88
Menu 12: USB Configuration	92
Menu 13: PCI/PnP Configuration	94
Menu 14: Boot	96
Menu 15: Boot Settings Configuration	97
Menu 16: Boot Device Priority Settings	99
Menu 17: Security	100
Menu 18: Chipset	101
Menu 19: North Bridge Chipset Configuration	102
Menu 20: South Bridge Chipset Configuration	105
Menu 21: Exit	106

Chapter

1

Introduction

1.1 Overview



Figure 1-1: PPC-37xx-N270 Panel PC

The PPC-37xx-N270 is an industrial flat panel PC. The PPC-37xx-N270 can be used for machine control, production lines, kiosks and information stations. The PPC-37xx-N270 is preinstalled with an Intel® Atom™ CPU for applications where more computing power is needed.

The PPC-37xx-N270 supports a second monitor for presenting information to customers or extending the display area. The second monitor can show different information to the main screen, or duplicate the main screen content.

The PPC-37xx-N270 can be installed in a rack, on a VESA clamp or in a custom enclosure with a hole of the correct size.

The PPC-37xx-N270 supports one 2.5" hard drive and a CompactFlash® disk for data and application storage. CompactFlash® is most often used for thin-client applications, where only basic functions are performed. A hard drive offers more storage space and is the better choice for a general use computer.

PPC-37xx-N270 Panel PC

1.1.1 Features

Some of the standard features of the PPC-37xx-N270 flat panel PC include:

- Preinstalled 1.6 GHz Intel® Atom™ N270 CPU
- Preinstalled 1.0 GB DDR2 SO-DIMM memory module
- Aluminum die-casting IP 65, high brightness industrial panel
- SATA interface support
- Dual GbE support
- Optional 802.11b/g/n wireless kit
- Simplified installation process
- Low power consumption and thermal distribution
- RoHS compliance

1.1.2 Model Variations

The model variations are listed in **Table 1-1**.

	CPU	Memory	Power
8.4"			
PPC-3708A-N270/R/1G-R22	1.6 GHz Intel® Atom™ N270	1.0 GB	60 W power supply 12 V DC input
10.4"			
PPC-3710A-N270/R/1G-R22	1.6 GHz Intel® Atom™ N270	1.0 GB	60 W power supply 12 V DC input
12.1"			
PPC-3712A/N270/R/1G-R22	1.6 GHz Intel® Atom™ N270	1.0 GB	60 W power supply 12 V DC input

Table 1-1: Model Variations

1.1.3 Applications

The flat panel PC is designed for rigorous industrial environments where it may be exposed to both heat and moisture. Its durability and strength also makes it an ideal choice for public access computers. Some possible applications include:

- Automated manufacturing processes
- Public information gathering point

1.2 External Overview

The flat panel PC is a rectangular cubic structure that comprises of a screen, rear panel, top panel, bottom panel and two side panels (left and right). An aluminum frame surrounds the front screen. The rear panel provides screw holes for a wall-mounting bracket, and an arm mounting interface. The bottom panel provides access to external interface connectors that include LAN, USB 2.0, audio, VGA, serial port connectors and CompactFlash® card slot.

1.2.1 Front Panel

The front side of the PPC-37xx-N270 is a flat panel TFT LCD screen surrounded by an aluminum frame.

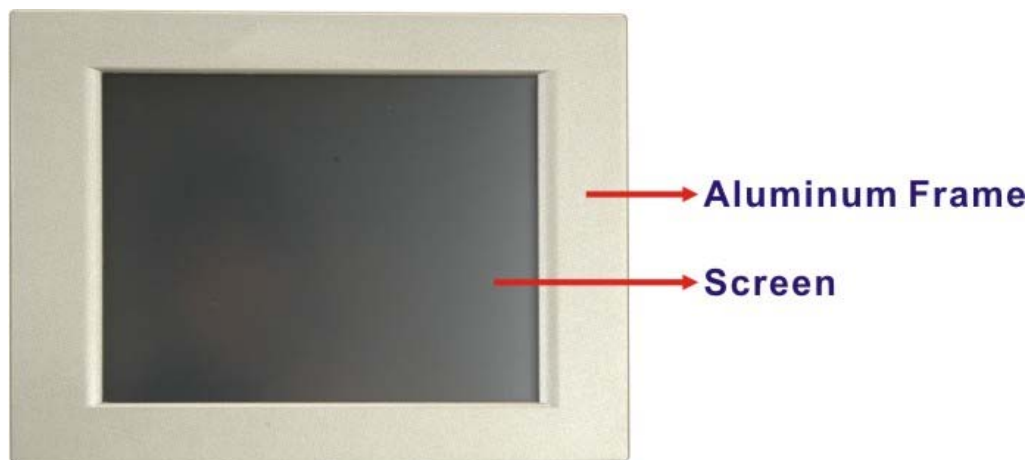

Figure 1-2: Front View

PPC-37xx-N270 Panel PC

1.2.2 Rear Panel

The rear panel provides access to a fan ventilation vent and four retention screw holes that support a wall-mounting bracket. **Figure 1-3** shows the retention screw holes of the PPC-3712A-N270.

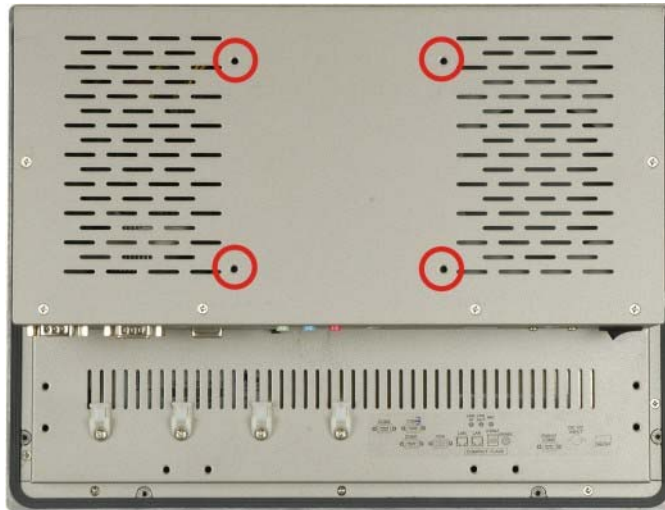

Figure 1-3: PPC-3712A-N270 Wall-Mounting Bracket Retention Screw Holes

1.2.3 Bottom Panel

The following is a list of the bottom panel peripheral device connectors on the PPC-37xx-N270. Diagrams for each other models are shown below.

- 1 x RS-232/422/485 port
- 2 x RS-232 ports
- 3 x Audio jacks (Line-in, Line-out and MIC-in)
- 1 x PS/2 keyboard/mouse connector
- 1 x AC power adapter connector
- 1 x VGA connector
- 2 x RJ-45 GbE connector
- 2 x USB 2.0 connectors
- 1 x CompactFlash® slot
- 1 x Power switch

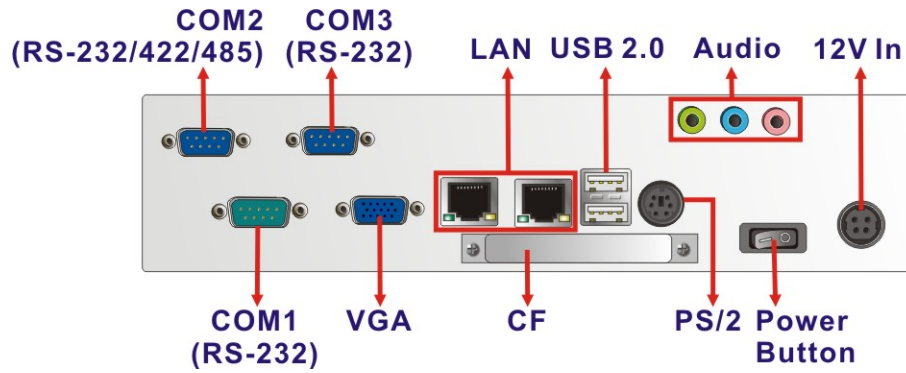

Figure 1-4: PPC-3708A-N270 Bottom View

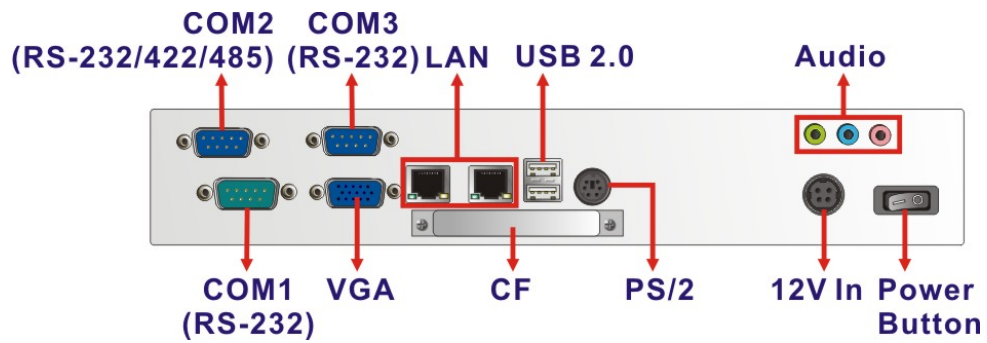

Figure 1-5: PPC-3710A-N270 Bottom View

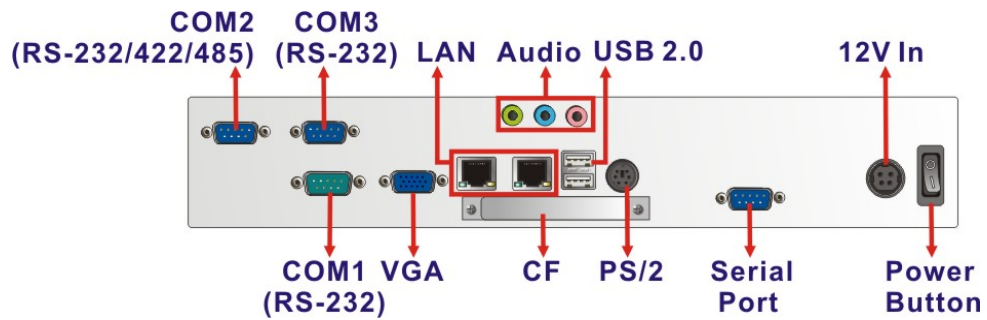

Figure 1-6: PPC-3712A-N270 Bottom View

PPC-37xx-N270 Panel PC

1.2.4 Side Panel

The both sides panel of the flat panel PC contain some vents for ventilation. The left side panel of PPC-3712 also provides access to the slim type CD-ROM bay (**Figure 1-7**).

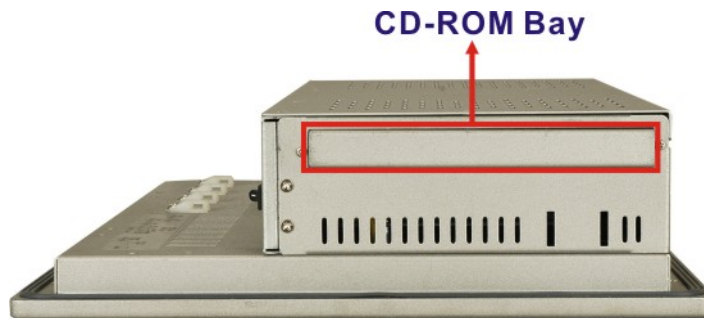

Figure 1-7: PPC-3712A-N270 Left View

1.2.5 Frame

An aluminum frame surrounds the TFT LCD screen. The aluminum frames of the PPC-3710 and PPC-3712 have small screw holes that are used when the flat panel PC is mounted into a rack or cabinet. These screws are circled in **Figure 1-8**.

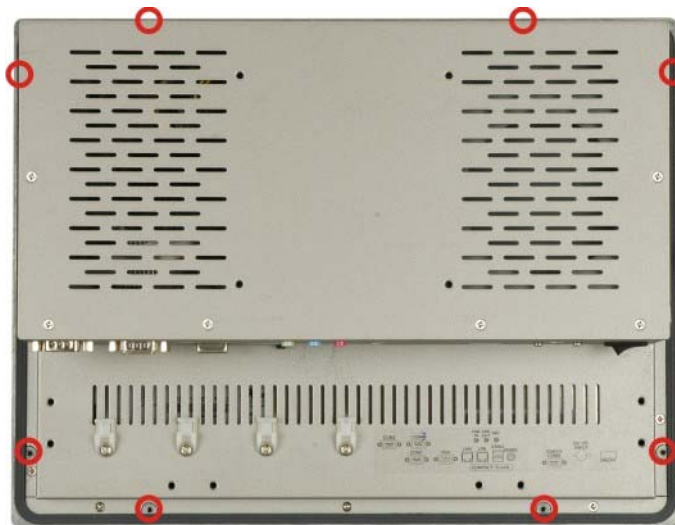

Figure 1-8: PPC-3712 Frame Rear View

1.3 Specifications

The technical specifications for the PPC-3708A, PPC-3710A and PPC-3712A system are listed in **Table 1-2**.

SPECIFICATION	PPC-3708A-N270	PPC-3710A-N270	PPC-3712A-N270
Front Panel	Aluminum Front Panel		
Chassis	Heavy-duty Steel		
LCD Panel	8.4" TFT LCD	10.4" TFT LCD	12.1" TFT LCD
Resolution	800 x 600 (SVGA)	800 x 600 (SVGA)	1024 x 768 (XGA)
Brightness	450 cd/m ²	400 cd/m ²	500 cd/m ²
Backlight MTBF	50,000 hrs	50,000 hrs	60,000 hrs
Contrast Ratio	600:1	700:1	700:1
Viewing Angle	160/140 (H-V)	160/140 (H-V)	160/160 (H-V)
Touch Screen	4-wire resistive type with RS-232 interface	5-wire resistive type with RS-232 interface	5-wire resistive type with RS-232 interface
CPU	1.6 GHz Intel® Atom™ N270 processor with a 533 MHz FSB		
Chipset	Intel® 945GSE and Intel® ICH7M		
Memory	Preinstalled 1 GB DDR2 SDRAM SO-DIMM memory module (system max. 2 GB)		
Display	Support Dual Display		
Expansion Slot	One PCIe Mini card slot supports PCIe v1.2 standard		
Drive Bay	1 x 2.5" HDD bay	1 x 2.5" HDD bay	1 x slim type CD-ROM 1 x 2.5" HDD bay
Power	60 W power adapter		
Mounting	Stand, rack, wall, panel or arm		
Color	Silver (PANTONE PMS-8001)		
Operating Temperature	-10°C ~+50°C with CF card 0°C ~+50°C with HDD		
Storage Temperature	-20°C ~+60°C		

PPC-37xx-N270 Panel PC

SPECIFICATION	PPC-3708A-N270	PPC-3710A-N270	PPC-3712A-N270
Relative Humidity	5% ~ 95%, non-condensing		
Vibration	5Hz - 17Hz, 0.1" double amplitude displacement. 17Hz - 640Hz, 1.5G acceleration, peak to peak.		
Shock	10G Acceleration, peak to peak (11ms)		
Dimension (mm)	243.57 x 178 x 75.2	311.5 x 242 x 77.8	340 x 260 x 73.4
Net/Gross Weight	2.2/4.4 kg	3.4/5.8 kg	6.0/8.0 kg

Table 1-2: System Specifications

Chapter

2

Detailed Specifications

PPC-37xx-N270 Panel PC

2.1 Dimensions

Dimensions for the PPC-37xx-N270 models are shown in the subsections below.

2.1.1 PPC-3708A-N270 Dimensions

The dimensions of the PPC-3708A-N270 flat panel PC are shown in **Figure 2-1** below.

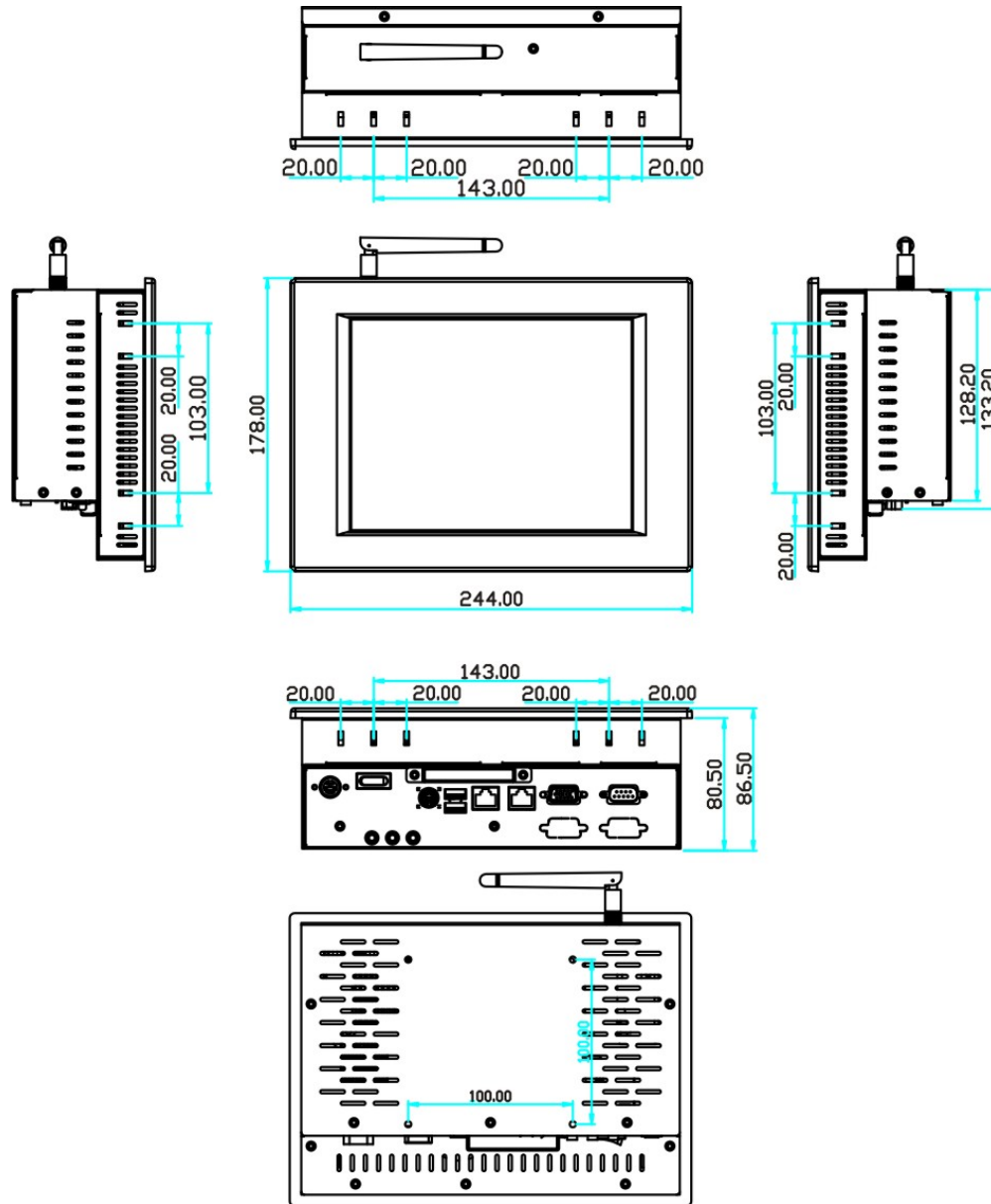

Figure 2-1: PPC-3708A-N270 Dimensions (units in mm)

2.1.2 PPC-3710A-N270 Dimensions

The dimensions of the PPC-3710A-N270 flat panel PC are shown in **Figure 2-2** below.

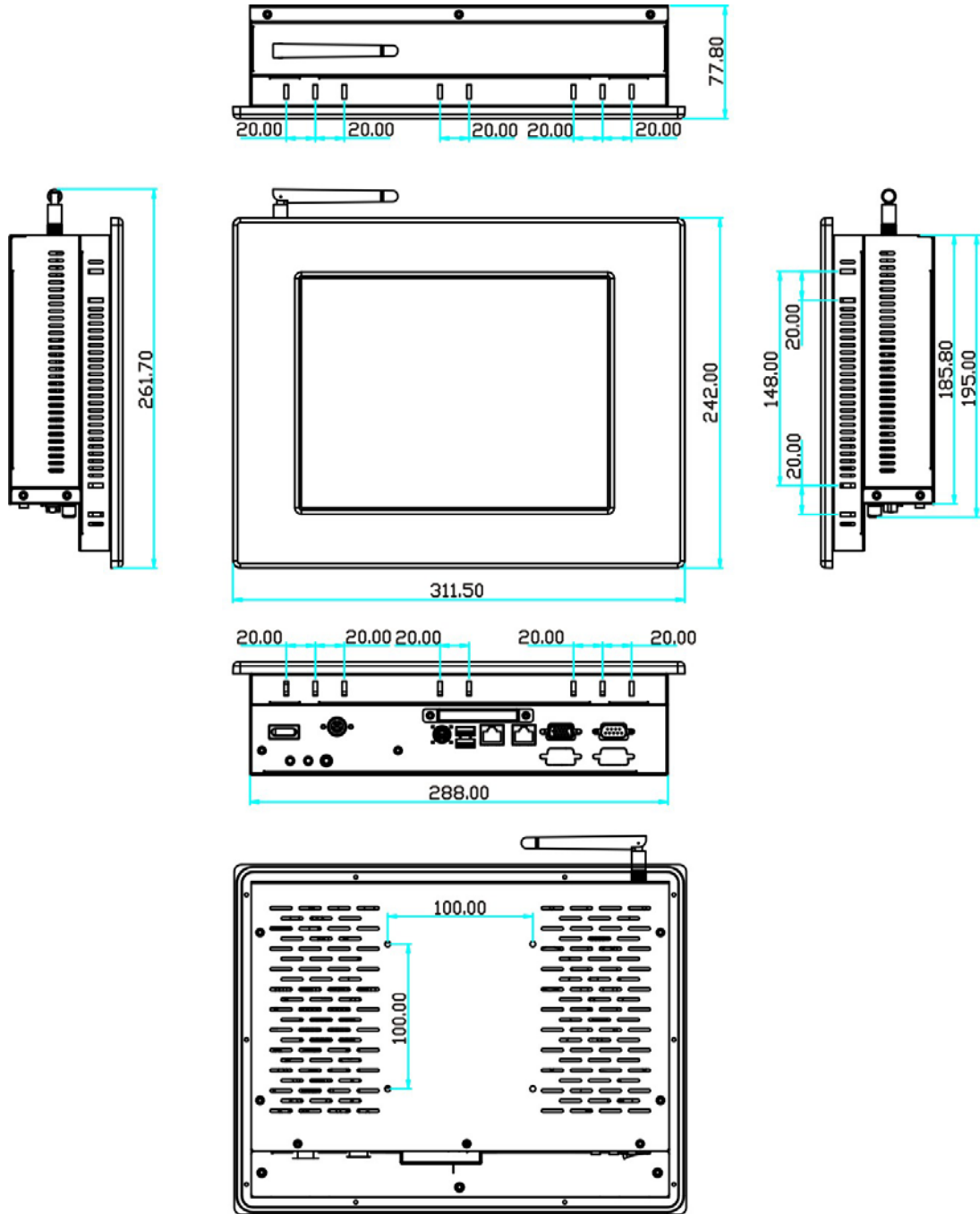

Figure 2-2: PPC-3710A-N270 Dimensions (units in mm)

PPC-37xx-N270 Panel PC

2.1.3 PPC-3712A-N270 Dimensions

The dimensions of the PPC-3712A-N270 flat panel PC are shown in **Figure 2-3** below.

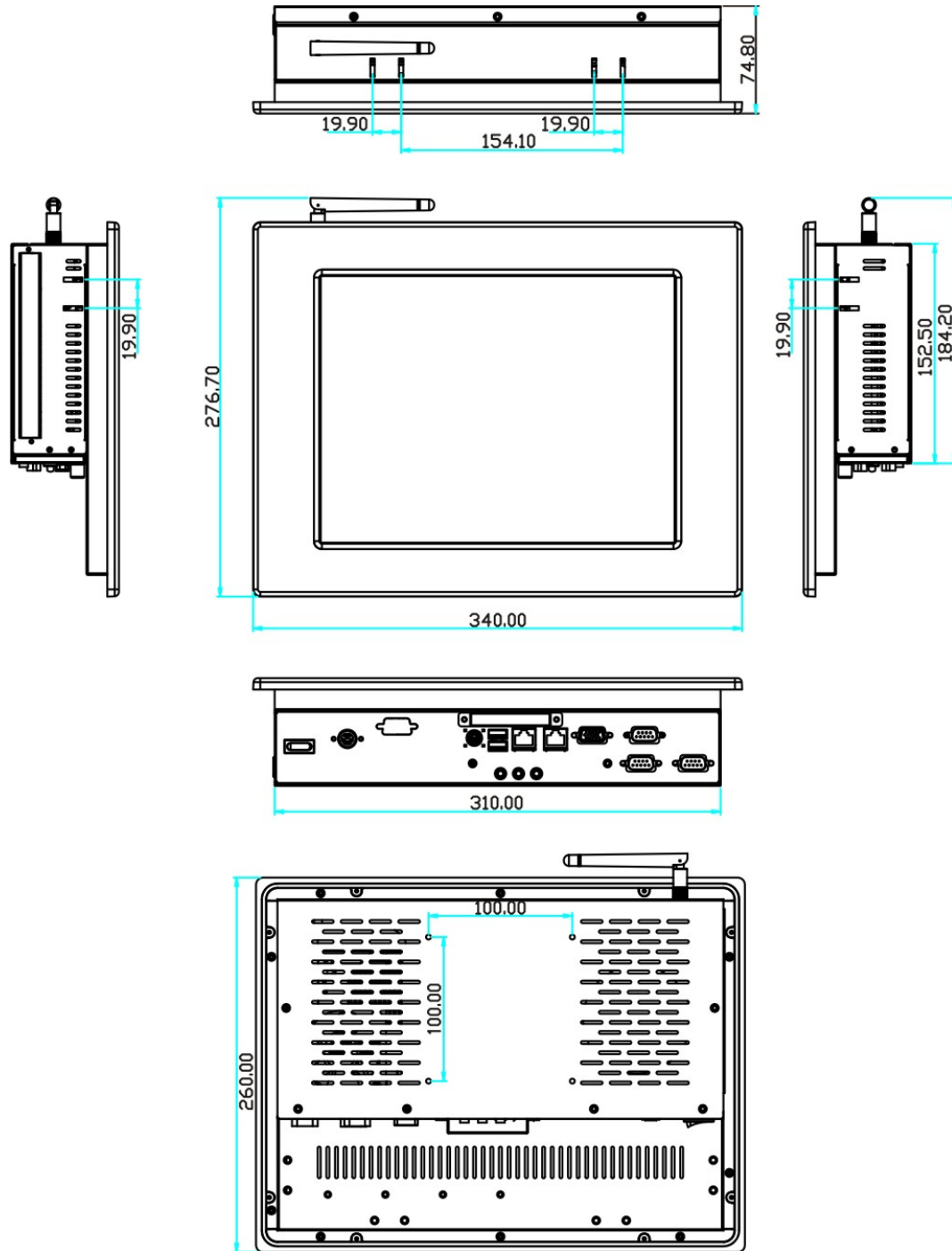

Figure 2-3: PPC-3712A-N270 Dimensions (units in mm)

2.2 Intel® Atom™ Processor

A 45nm N270 Intel® Atom™ processor is installed in the system. The processor has a CPU speed of 1.6 GHz and a 533 MHz front side bus (FSB). The processor also comes with a 512 KB L2 cache and a 1.6 GHz L2 cache speed. Some of the features of the Intel® Atom™ processor N270 are listed below:

- On-die, primary 32-kB instructions cache and 24-kB write-back data cache
- 533-MHz source-synchronous front side bus (FSB)
- 2-Threads support
- On-die 512-kB, 8-way L2 cache
- Support for IA 32-bit architecture
- Intel® Streaming SIMD Extensions-2 and -3 (Intel® SSE2 and Intel® SSE3) support and Supplemental Streaming SIMD Extension 3 (SSSE3) support
- Micro-FCBGA8 packaging technologies
- Thermal management support via Intel® Thermal Monitor 1 and Intel Thermal Monitor 2
- FSB Lane Reversal for flexible routing
- Supports C0/C1(e)/C2(e)/C4(e)
- L2 Dynamic Cache Sizing
- Advanced power management features including Enhanced Intel SpeedStep® Technology
- Execute Disable Bit support for enhanced security

2.3 Motherboard Components

The following sections describe some of the features on the motherboard.

2.3.1 Memory Support

2.3.1.1 Installed Memory

One 200-pin 1.0 GB 533 MHz DDR2 SDRAM SO-DIMM is installed in the PPC-37xx-N270 and controlled by the Intel® 945GSE GMCH installed on the internal motherboard.

PPC-37xx-N270 Panel PC

2.3.1.2 Additional Memory

The Intel® 945GSE is capable of supporting one 200-pin 2.0 GB (max.) 533 MHz or 400 MHz DDR2 SDRAM SO-DIMM. If additional memory is required, please contact an IEI sales representative and discuss the necessary system requirement.

2.3.2 Storage Capacity

The PPC-37xx-N270 series supports an easily installed CompactFlash® Type II (CF Type II) memory disk. The PPC-37xx-N270 also supports an internal 2.5" SATA drive. The PPC-3712A-N270 model can also support a slim type optical drive.

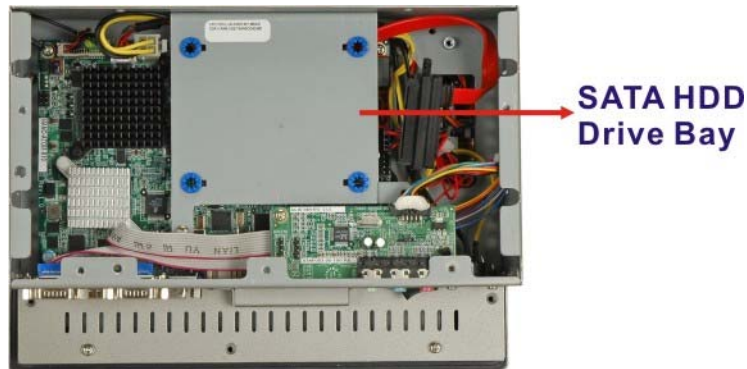

Figure 2-4: PPC-3708A SATA Hard Disk Drive Bay

The system can also support a CompactFlash® Type II (CF Type II) memory disk (Figure 2-5).

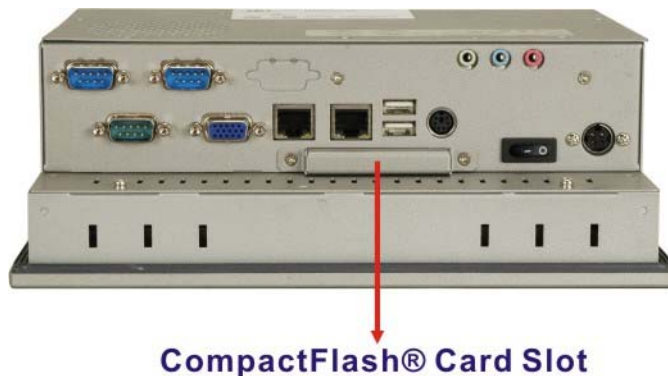

Figure 2-5: PPC-3708A CompactFlash® Slot

2.4 External Peripheral Interface Connectors

The following section describes the external peripheral interface connectors on the bottom panel of the subsystem.

2.4.1 Serial Port Connectors

The PPC-37xx-N270 has three serial ports. Two of these ports (COM1 and COM3) are RS-232 only port. The remaining serial port (COM2) can be configured as a RS-232, RS-422 or an RS-485 serial port. The PPC-3712A-N270 has one extra RS-232 serial port on the bottom panel.

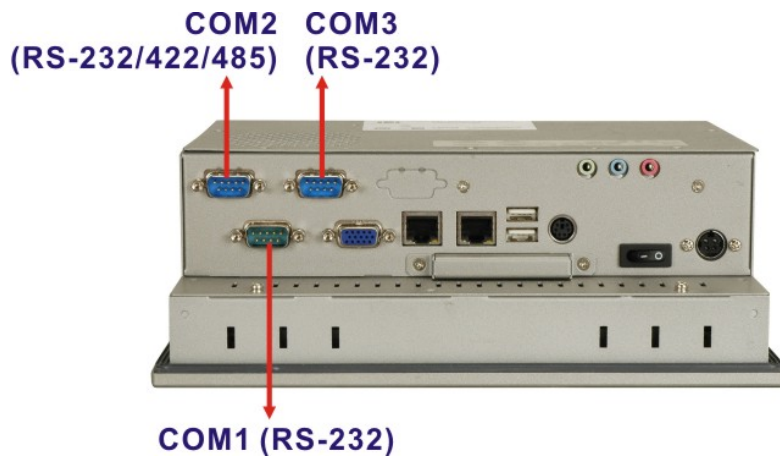

Figure 2-6: PPC-3708A COM Ports

PPC-37xx-N270 Panel PC

2.4.2 LAN Connectivity

The PPC-37xx-N270 has two RJ-45 LAN connectors on the bottom panel.

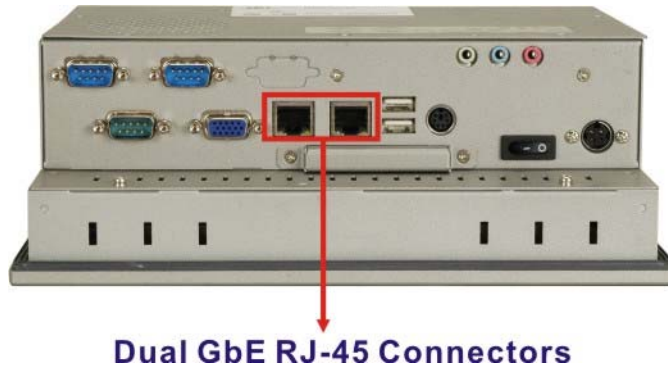

Figure 2-7: PPC-3708A RJ-45 Ethernet Connectors

The PCIe lane from the Intel® ICH7 chipset of the PPC-37xx-N270 is interfaced to the Realtek RTL8111E PCIe gigabit Ethernet (GbE) controllers. The RTL8111E controllers are then connected directly to the RJ-45 connectors on the bottom panel and provides external GbE connectivity. Some of the RTL8111E controller features are listed below:

- Integrated 10/100/1000 transceiver
- Supports PCI Express™ 1.1
- Fully compliant with IEEE 802.3, IEEE 802.3u, IEEE 802.3ab
- Supports IEEE 802.1P Layer 2 Priority Encoding
- Supports IEEE 802.1Q VLAN tagging
- Serial EEPROM
- Transmit/Receive on-chip buffer support

2.4.3 External USB Connectors

There are two USB 2.0 connectors on the bottom panel of the PPC-37xx-N270 (the PPC-37xxB-N270 series has four USB connectors). Both USB 2.0 connectors are interfaced directly to the USB controllers on the ICH7-M southbridge. These USB connectors are fully compliant with USB specification Revision 2.0 and USB specification Revision 1.1 and can be interfaced to both USB 1.1 and USB 2.0 compliant devices.

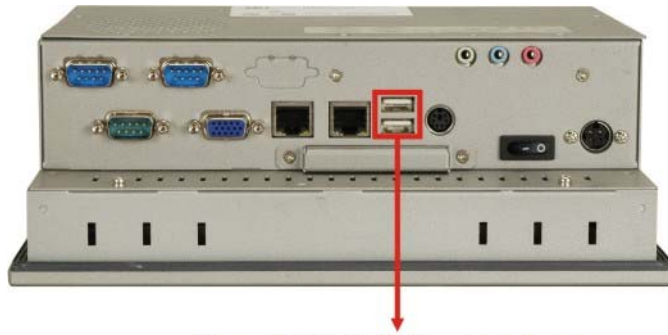

Two USB 2.0 Connectors

Figure 2-8: PPC-3708A External USB Ports

2.4.4 Keyboard and Mouse Connectivity

The PS/2 keyboard/mouse connector on the bottom panel interface to a super I/O chipset on the motherboard that connects through the LPC bus to the ICH7-M southbridge chipset.

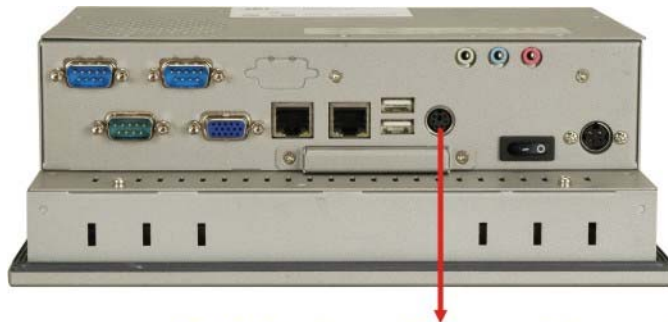

PS/2 Keyboard/Mouse Connector

Figure 2-9: PPC-3708A PS/2 Connector

PPC-37xx-N270 Panel PC

2.5 PPC-37xx-N270 Front Side

2.5.1 Monitor

A LCD screen is installed on the front of the PPC-37xx-N270 series. The monitor maximum resolution is varied in different PPC-37xx-N270 models. The screen is shown in **Figure 2-10** below.

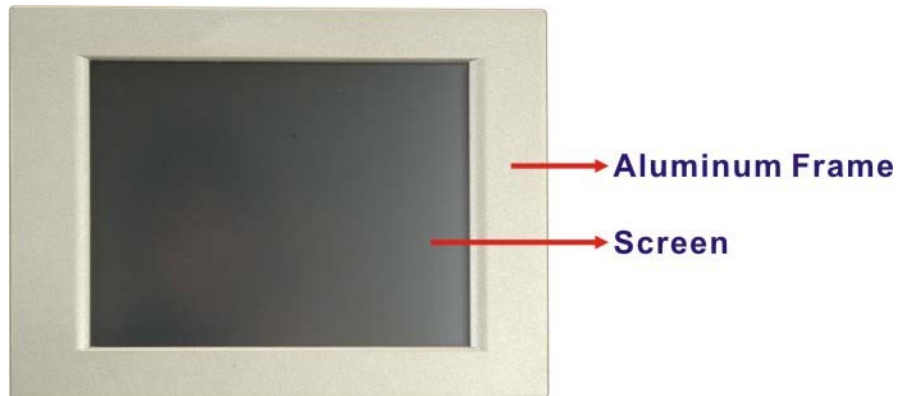

Figure 2-10: LCD Screen

2.5.2 Touch-Screen Module

A controller for the 4-wire/5-wire resistive touch screen is installed on the motherboard. The sensitive touch screen is accurate, reliable and durable.

2.6 Graphics

2.6.1 Intel® 945GSE Integrated Graphics Engine

The Intel® 945GSE has the Intel® Gen 3.5 graphics engine integrated into the chipset and interfaced to the VGA connector on the bottom panel of the PPC-37xx-N270. The Intel® Gen 3.5 has 250 MHz core render clock and 200 MHz core display clock at 1.05 V core voltage.

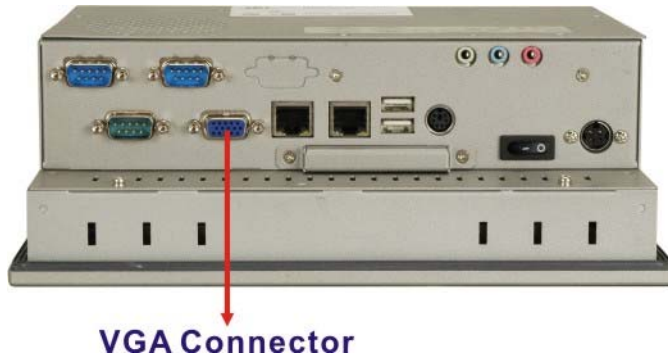

Figure 2-11: PPC-3708A VGA Connector

2.6.2 Dual-Display

The system supports dual display capabilities. The second display device can be connected to the PPC-37xx-N270 through the VGA connector described above.

2.7 Audio

The integrated AC'97 Audio compliant audio controller on the Intel® ICH7 Southbridge is connected to a 5.1 channel audio kit with RealTek ALC655 audio codec. The audio kit is then connected to three external audio jacks, which are then connected to compliant audio devices. The RealTek ALC655 is a 16-bit AC-'97 Rev. 2.3 compatible six-channel audio codec. The audio connectors are shown in **Figure 2-12**.

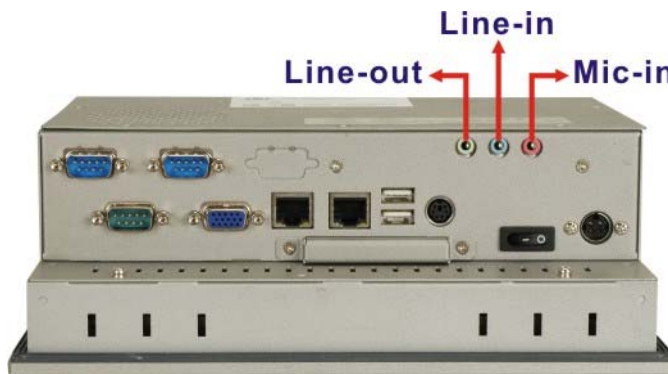

Figure 2-12: PPC-3708A Audio Jack

PPC-37xx-N270 Panel PC

2.8 System Power

The standard system is shipped with a 90 V to 264 V AC power adapter that has a maximum power output of 60 W. The power adapter has a 12 V DC output connector. The PPC-37xxA-N270 series has one 12 V power input connector on the bottom panel. The power connector is shown in **Figure 2-13** below.



Figure 2-13: Power Connector

Chapter

3

Unpacking

PPC-37xx-N270 Panel PC

3.1 Unpacking

To unpack the flat panel PC, follow the steps below:







WARNING!

The front side LCD screen has a protective plastic cover stuck to the screen. Only remove the plastic cover after the flat panel PC has been properly installed. This ensures the screen is protected during the installation process.

- Step 1:** Use box cutters, a knife or a sharp pair of scissors that seals the top side of the external (second) box.
- Step 2:** Open the external (second) box.
- Step 3:** Use box cutters, a knife or a sharp pair of scissors that seals the top side of the internal (first) box.
- Step 4:** Lift the monitor out of the boxes.
- Step 5:** Remove both polystyrene ends, one from each side.
- Step 6:** Pull the plastic cover off the flat panel PC.
- Step 7:** Make sure all the components listed in the packing list are present.



3.1.1 Packing List

The PPC-37xx-N270 flat panel PC is shipped with the following components:

Quantity	Item	Image
Standard		
1	PPC-37xx-N270 series	
1	Power adapter (P/N: 63040-010060-050-RS)	
1	Power cord (P/N: 32702-000200-100-RS)	
1	KB/MS PS/2 Y-cable (P/N: 32006-000300-100-RS)	
1	Optical drive SATA cable for PPC-3712-N270 (P/N: 32801-006300-100-RS)	
1	Mini jumper pack (2.0mm)	
1	Screw kit (P/N: 19600-000207-RS)	

PPC-37xx-N270 Panel PC

1	User manual CD and driver CD	
1	One Key Recovery CD (P/N: IEI-7B000-000478-RS)	
1	Touch pen	
1	Wall Mount Kit (P/N: 41020-016102-00-RS, 41014-057602-00-RS)	
1	Panel mounting kit (P/N: 19Z00-000024-RS)	
Optional		
	Stand (P/N: STAND-100-RS)	
	Rack Mount Kit (P/N: RK-084MS-R10 RK-104MS-R10 RK-121MS-R10)	

<p>Arm (P/N: ARM-11-RS)</p>	
<p>HDD IDE Cable 25 CM (P/N: 32200-000037-RS)</p>	
<p>DVD-ROM adapter kit (P/N: 19Z00-000112-RS)</p>	

If any of these items are missing or damaged, contact the distributor or sales representative immediately.

Chapter

4

Installation

4.1 Anti-static Precautions



WARNING:

Failure to take ESD precautions during the maintenance of the PPC-37xx-N270 may result in permanent damage to the PPC-37xx-N270 and severe injury to the user.

Electrostatic discharge (ESD) can cause serious damage to electronic components, including the PPC-37xx-N270. Dry climates are especially susceptible to ESD. It is therefore critical that whenever the PPC-37xx-N270 is accessed internally, or any other electrical component is handled, the following anti-static precautions are strictly adhered to.

- **Wear an anti-static wristband:** - Wearing a simple anti-static wristband can help to prevent ESD from damaging the board.
- **Self-grounding:** - Before handling the board touch any grounded conducting material. During the time the board is handled, frequently touch any conducting materials that are connected to the ground.
- **Use an anti-static pad:** - When configuring the PPC-37xx-N270, place it on an anti-static pad. This reduces the possibility of ESD damaging the PPC-37xx-N270.
- **Only handle the edges of the PCB:** - When handling the PCB, hold the PCB by the edges.

4.2 Installation Precautions

When installing the flat panel PC, please follow the precautions listed below:

- **Power turned off:** When installing the flat panel PC, make sure the power is off. Failing to turn off the power may cause severe injury to the body and/or damage to the system.
- **Certified Engineers:** Only certified engineers should install and modify onboard functionalities.

PPC-37xx-N270 Panel PC

- **Anti-static Discharge:** If a user open the rear panel of the flat panel PC, to configure the jumpers or plug in added peripheral devices, ground themselves first and wear an anti-static wristband.

4.3 Preinstalled Components

The following components are all preinstalled.

- Motherboard
- TFT LCD screen
- 1.0 GB DDR2 memory module
- Resistive type touch screen

Preinstalled customizations may include the following.

- Different DDR2 memory module
- Hard disk drive
- Optical drive (PPC-3712A-N270)

Component installation is described in **the following sections**.

4.4 Installation and Configuration Steps

The following installation steps must be followed.

Step 1: Unpack the flat panel PC

Step 2: Set the jumper settings (not usually necessary)

Step 3: Install HDD and CD drive

Step 4: Mount the flat panel PC

Step 5: Connect peripheral devices to the bottom panel of the flat panel PC

Step 6: Configure the system

4.5 Remove the Back Cover

4.5.1 PPC-3708 Back Cover Removal

The back cover of the PPC-3708 is secured to the chassis with seven retention screws, five on the rear panel and two on the top panel (**Figure 4-1**). Remove the seven retention screws and lift the cover off the PPC-3708.

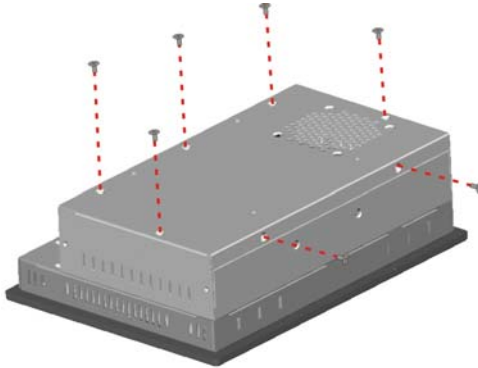

Figure 4-1: PPC-3708 Back Cover Retention Screws

4.5.2 PPC-3710 Back Cover Removal

The back cover of the PPC-3710 is secured to the chassis with ten retention screws, seven on the rear panel and three on the top panel (**Figure 4-2**). Remove the ten retention screws and lift the cover off the PPC-3710.

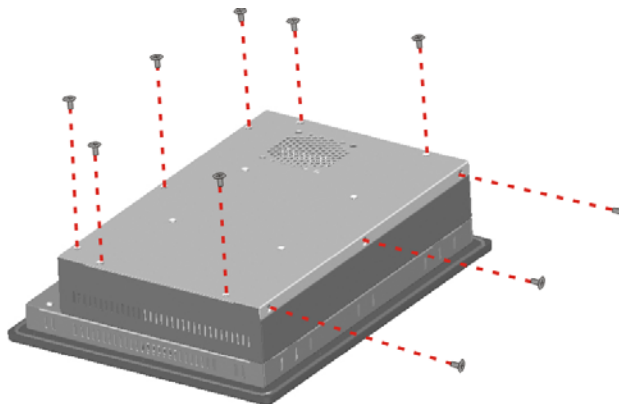

Figure 4-2: PPC-3710 Back Cover Retention Screws

PPC-37xx-N270 Panel PC

4.5.3 PPC-3712 Back Cover Removal

The back cover is secured to the chassis with nine retention screws, six on the rear panel and three on the top panel (**Figure 4-3**). Remove the nine retention screws and lift the cover off the PPC-3712.

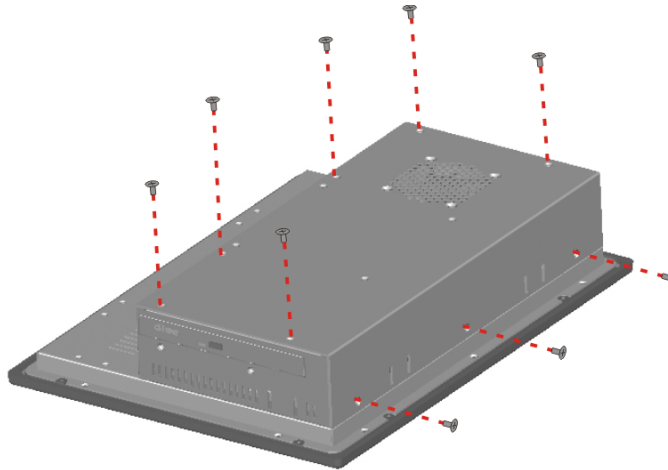

Figure 4-3: PPC-3712 Back Cover Retention Screws

4.6 Jumper Settings

The jumper settings are all described in **Section 4.6**. During normal installation, these settings should not be changed

4.7 CompactFlash® Card Installation

To install a CF Type II card onto the PPC-37xx-N270, please follow the steps below:

- Step 1:** **Locate the CF card socket.** Place the PPC-37xx-N270 on an anti-static pad with the solder side facing up. Locate the CF card socket.
- Step 2:** **Remove the CF card socket cover.** The socket cover is secured to the chassis with two retention screws. Remove the two retention screws to remove the socket cover.
- Step 3:** **Align the CF card.** Make sure the CF card is properly aligned with the CF socket.

Step 4: Insert the CF card. Gently insert the CF card into the socket making sure the socket pins are properly inserted into the socket. See **Figure 4-4**.

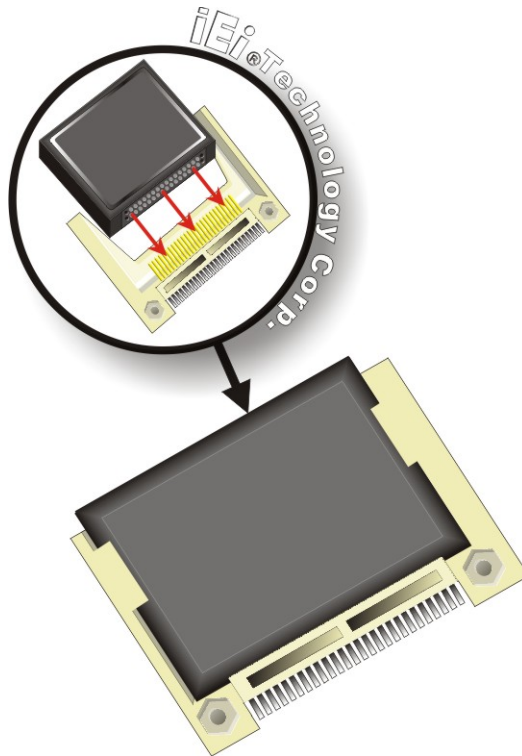

Figure 4-4: CF Card Installation

4.8 HDD Installation

4.8.1 PPC-3708 HDD Installation

To install the HDD into the PPC-3708, please follow the steps below:

- Step 1:** Remove the back cover. Refer to **Section 4.5.1**.
- Step 2:** Remove the HDD bracket from the PPC-3708. The HDD bracket is attached on the PPC-3708 with four retention screws, two on the top panel (**Figure 4-5**) and two inside the chassis (**Figure 4-6**). Remove the four retention screws and lift the bracket off the panel PC.

PPC-37xx-N270 Panel PC



Figure 4-5: PPC-3708 HDD Bracket Retention Screws (Top Panel)



Figure 4-6: PPC-3708 HDD Bracket Retention Screws (Inside)

Step 3: Attach the HDD bracket to the HDD. To do this, align the four retention screw holes in the HDD bracket with the retention screw holes on the bottom of the HDD. Insert four retention screws into the HDD bracket. (**Figure 4-7**).

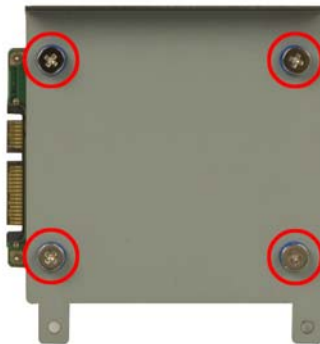

Figure 4-7: PPC-3708 HDD Retention Screws

Step 4: Install the HDD into the PPC-3708 by aligning the retention screw holes in the HDD bracket with the retention screw holes on the panel PC. Insert the four retention screws.

Step 5: Connect the SATA cable from the motherboard to the rear of the HDD.

4.8.2 PPC-3710 HDD Installation

To install the HDD into the PPC-3710, please follow the steps below:

Step 1: Remove the back cover. See **Section 4.5.2** above.

Step 2: Remove the HDD bracket from the PPC-3710. The HDD bracket is attached on the PPC-3710 with four retention screws inside the chassis (**Figure 4-8**).

Remove the four retention screws and lift the bracket off the panel PC.

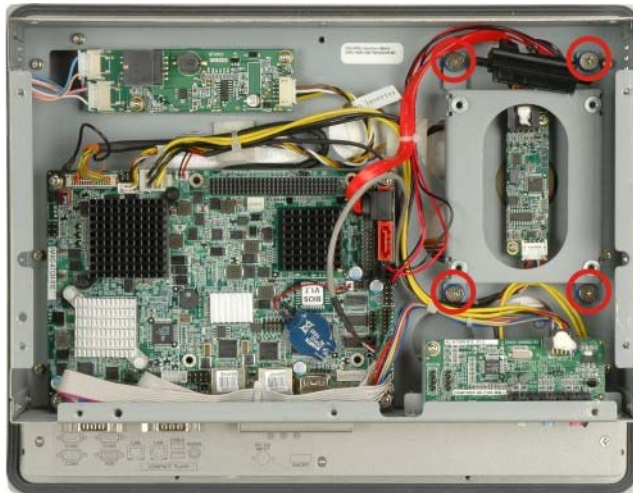

Figure 4-8: PPC-3710 HDD Bracket Retention Screws

Step 3: Attach the HDD bracket to the HDD. To do this, align the four retention screw holes in the HDD bracket with the retention screw holes on the bottom of the HDD. Insert four retention screws into the HDD bracket. (**Figure 4-9**).

PPC-37xx-N270 Panel PC



Figure 4-9: PPC-3710 HDD Retention Screws

Step 4: Install the HDD into the PPC-3710 by aligning the retention screw holes in the HDD bracket with the retention screw holes on the panel PC. Insert the four retention screws.

Step 5: Connect the SATA cable from the motherboard to the rear of HDD.

4.8.3 PPC-3712 HDD Installation

To install the HDD, please follow the steps below:

Step 1: Remove the back cover. See **Section 4.5.3** above.

Step 2: Remove the CD-ROM bracket. See **Section 4.9 Step 3** below.

Step 3: Attach the HDD brackets to the HDD. To do this, align the two retention screw holes in each HDD bracket with the retention screw holes on the side of the HDD. Insert two retention screws into both brackets on both sides of the HDD (**Figure 4-10**).

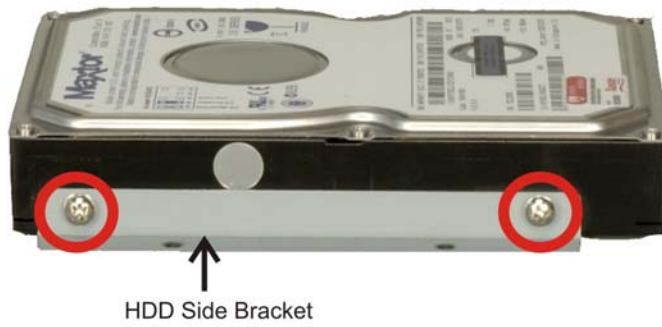

Figure 4-10: PPC-3712 HDD Bracket Retention Screws

Step 4: Install the HDD into the PPC-3712 by aligning the retention screw holes in the base of the HDD brackets with the retention screw holes on the metal sheet. Insert the four retention screws, two into the base of each HDD bracket (Figure 4-11.)

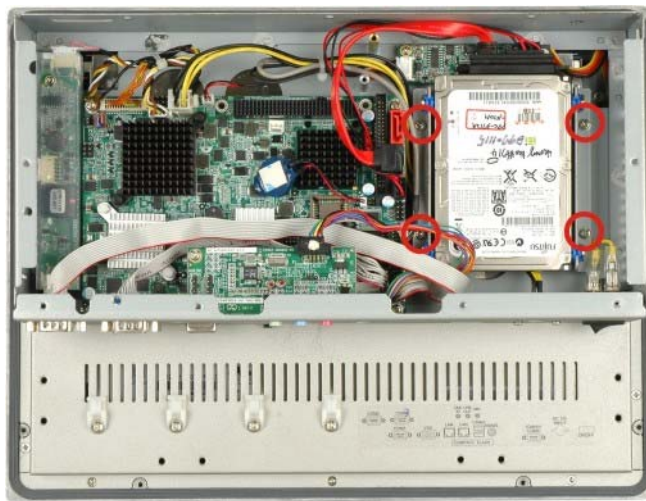

Figure 4-11: PPC-3712 HDD Retention Screws

Step 5: Connect the SATA cable from the SATA connector on the motherboard to the rear of HDD.

4.9 CD Drive Installation (PPC-3712A-N270 Only)

To install the CD drive into the PPC-3712A, please follow the steps below:

- Step 1:** Remove the back cover. See **Section 4.5** above.
- Step 2:** Remove the CD drive bracket from the PPC-3712A-N270. To do this, remove three retention screws, two on the side panel and one inside the panel PC (**Figure 4-12**).



Figure 4-12: PPC-3712A CD Drive Bracket

- Step 3:** Remove the CD drive cover bracket by removing the four retention screws shown in **Figure 4-13**.

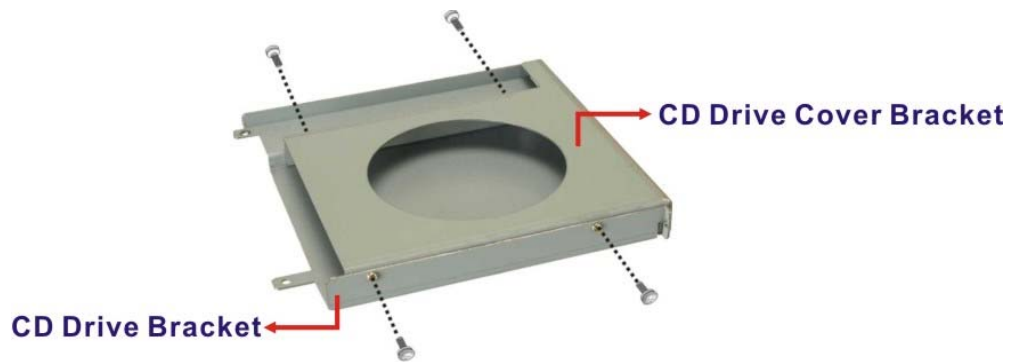

Figure 4-13: CD Drive Cover Bracket Retention Screws

- Step 4:** Attach the CD drive bracket to the CD drive. To do this, align the four retention screw holes in the CD drive bracket with the retention screw holes on the side of the CD drive. Insert four retention screws into the bracket on both sides of the HDD.
- Step 5:** Install the CD drive into the PPC-3712A by aligning the retention screw holes in the sides of the CD drive bracket with the retention screw holes on the left panel and inside the chassis. Insert the three retention screws.
- Step 6:** Connect the CD-ROM SATA cable and power cable from the connectors on the motherboard to the rear of the CD drive.

4.10 Jumper Settings



NOTE:

A jumper is a metal bridge used to close an electrical circuit. It consists of two or three metal pins and a small metal clip (often protected by a plastic cover) that slides over the pins to connect them. To CLOSE/SHORT a jumper means connecting the pins of the jumper with the plastic clip and to OPEN a jumper means removing the plastic clip from a jumper.

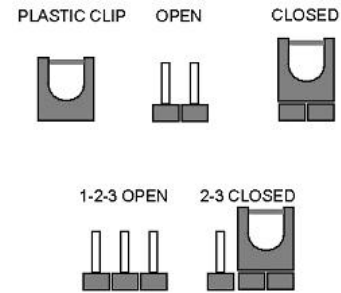

Figure 4-14: Jumper Locations

The following jumpers can be found on the motherboard installed in the PPC-37xx-N270. Before the PPC-37xx-N270 is installed, the jumpers must be set in accordance with the desired configuration. The jumpers on the PPC-37xx-N270 motherboard are listed in **Table 4-1**.

Description	Label	Type
AT Power Mode Setting	ATXCTL1	3-pin wafer
CF Card Setting	JCF1	2-pin header
Clear CMOS	J_CMOS1	3-pin header
COM2 Mode Setting	JP1	6-pin header

Table 4-1: Jumpers

4.10.1 Access the Jumpers

To access the jumpers, remove the back panel. To remove the back panel, please refer to **Section 4.5**.

4.10.2 Preconfigured Jumpers



WARNING:

Do not change the settings on the jumpers in described here. Doing so may disable or damage the system.

The following jumpers are preconfigured for the PPC-37xx-N270. Users should no change these jumpers (**Table 4-2**).

Jumper Name	Label	Type
LVDS voltage selection	J_VLVDS1	3-pin header
LVDS2 Voltage Select	J_VLVDS2	3-pin header
Panel Type and Resolution	J_LCD_TYPE1	8-pin header

Table 4-2: Preconfigured Jumpers

4.10.3 AT Power Select Jumper Settings



NOTE:

The AT Power Select Jumper is the same as the ATX Enable connector.

- Jumper Label:** ATXCTI1
- Jumper Type:** 3-pin wafer
- Jumper Settings:** See **Table 4-3**
- Jumper Location:** See **Figure 4-15**

The AT Power Select jumper specifies the systems power mode as AT or ATX. Use a jumper cap to short pin 1 - pin 2 on the ATXCTL1 connector to enable the AT Power mode on the system. In the ATX mode use the PS_ON- and 5VSB cable. AT Power Select jumper settings are shown in **Table 4-3**.

PPC-37xx-N270 Panel PC

AT Power Select	Description	
Short 1 – 2	Use AT power	Default
Open	Use ATX power	

Table 4-3: AT Power Select Jumper Settings

The location of the AT Power Select jumper is shown in **Figure 4-15** below.

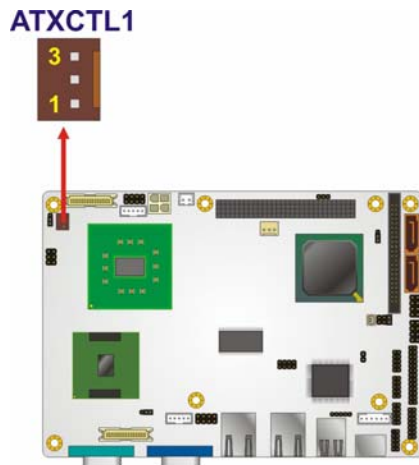

Figure 4-15: AT Power Select Jumper Location

4.10.4 CF Card Setup

- Jumper Label:** JCF1
- Jumper Type:** 2-pin header
- Jumper Settings:** See **Table 4-4**
- Jumper Location:** See **Figure 4-16**

The CF Card Setup jumper sets the CF Type I card or CF Type II cards as either the slave device or the master device. CF Card Setup jumper settings are shown in **Table 4-4**.

CF Card Setup	Description	
Open	Slave	Default
Closed	Master	

Table 4-4: CF Card Setup Jumper Settings

The CF Card Setup jumper location is shown in **Figure 4-16**.

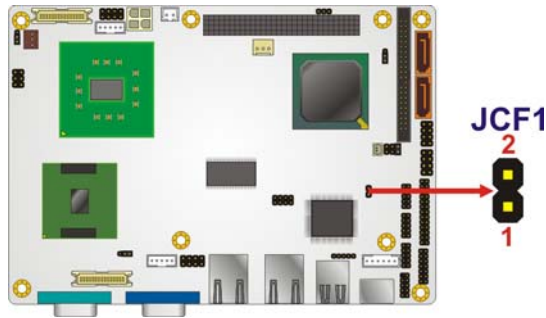

Figure 4-16: CF Card Setup Jumper Location

4.10.5 Clear CMOS Jumper

Jumper Label:	J_CMOS1
Jumper Type:	3-pin header
Jumper Settings:	See Table 4-5
Jumper Location:	See Figure 4-17

If the PPC-37xx-N270 fails to boot due to improper BIOS settings, the clear CMOS jumper clears the CMOS data and resets the system BIOS information. To do this, use the jumper cap to close pins 2 and 3 for a few seconds then reinstall the jumper clip back to pins 1 and 2.

If the “CMOS Settings Wrong” message is displayed during the boot up process, the fault may be corrected by pressing the F1 to enter the CMOS Setup menu. Do one of the following:

- Enter the correct CMOS setting
- Load Optimal Defaults
- Load Failsafe Defaults.

After having done one of the above, save the changes and exit the CMOS Setup menu.

The clear CMOS jumper settings are shown in **Table 4-5**.

PPC-37xx-N270 Panel PC

AT Power Select	Description	
Short 1 - 2	Keep CMOS Setup	Default
Short 2 - 3	Clear CMOS Setup	

Table 4-5: Clear CMOS Jumper Settings

The location of the clear CMOS jumper is shown in **Figure 4-17** below.

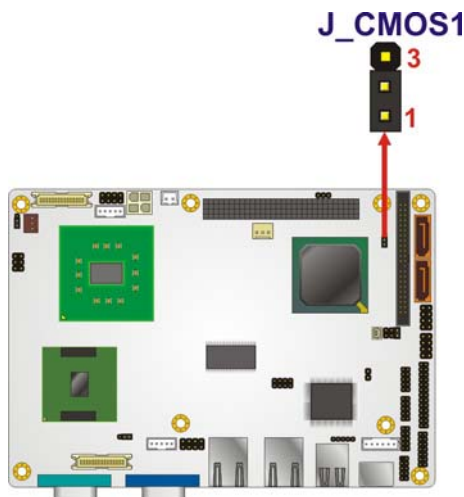

Figure 4-17: Clear CMOS Jumper

4.10.6 COM 2 Function Select Jumper

- Jumper Label:** JP1
- Jumper Type:** 6-pin header
- Jumper Settings:** See **Table 4-6**
- Jumper Location:** See **Figure 4-18**

The COM 2 Function Select jumper sets the communication protocol used by the second serial communications port (COM 2) as RS-232, RS-422 or RS-485. The COM 2 Function Select settings are shown in **Table 4-6**.

COM 2 Function Select	Description	
Short 1-2	RS-232	Default
Short 3-4	RS-422	

Short 5-6	RS-485	
-----------	--------	--

Table 4-6: COM 2 Function Select Jumper Settings

The COM 2 Function Select jumper location is shown in **Figure 4-18**.

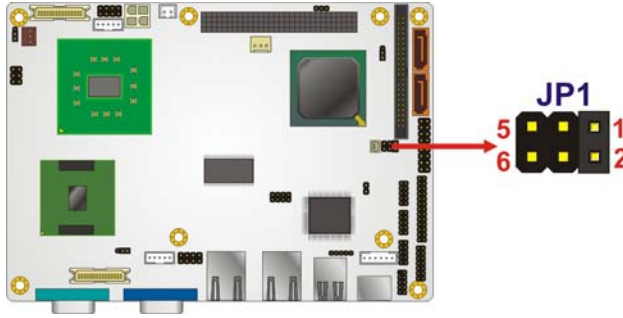

Figure 4-18: COM 2 Function Select Jumper Location

4.10.6.1 COM2 RS-422 and RS-485 Pinouts

The pinouts for RS-422 and RS-485 operation of external serial port COM 2 are detailed below.

COM 2	RS-422 Description
Pin 1	TX-
Pin 2	TX+
Pin 6	RX-
Pin 7	RX+

Table 4-7: RS-422 Pinouts

COM 2	RS-485 Description
Pin 1	Data-
Pin 2	Data+

Table 4-8: RS-485 Pinouts

4.11 Mounting the System



WARNING!

When mounting the flat panel PC onto an arm, onto the wall or onto a panel, it is better to have more than one person to help with the installation to make sure the flat panel PC does not fall down and get damaged.

The four methods of mounting the flat panel PC are listed below.

- Wall mounting
- Panel mounting
- Arm mounting
- Rack mounting

The four mounting methods are described below.

4.11.1 Wall Mounting

To mount the PPC-37xx-N270 flat panel PC onto a wall, please follow the steps below.

Step 1: Select the location on the wall for the wall-mounting bracket.

Step 2: Carefully mark the locations of the four bracket screw holes on the wall.

Step 3: Drill four pilot holes at the marked locations on the wall for the bracket retention screws.

Step 4: Align the wall-mounting bracket screw holes with the pilot holes.

Step 5: Secure the mounting-bracket to the wall by inserting the retention screws into the four pilot holes and tightening them (**Figure 4-19**).

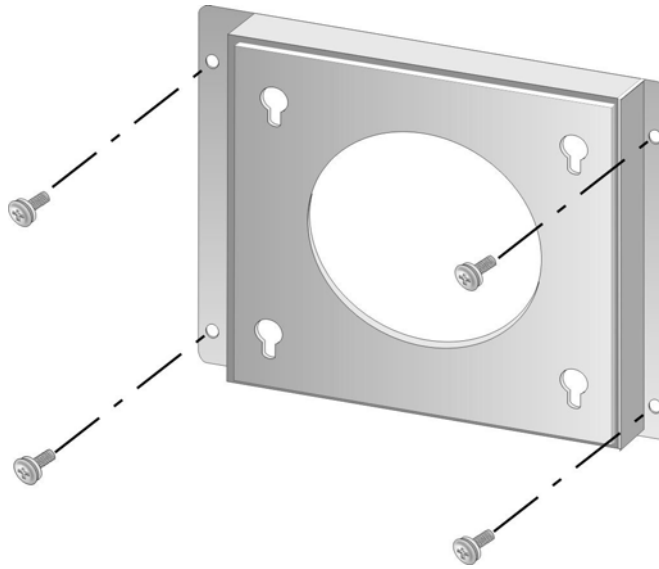

Figure 4-19: Wall-mounting Bracket

- Step 6:** Insert the four monitor mounting screws provided in the wall mounting kit into the four screw holes on the rear panel of the monitor and tighten until the screw shank is secured against the rear panel (**Figure 4-20**).
- Step 7:** Align the mounting screws on the monitor rear panel with the mounting holes on the bracket.
- Step 8:** Carefully insert the screws through the holes and gently pull the monitor downwards until the monitor rests securely in the slotted holes (**Figure 4-20**). Ensure that all four of the mounting screws fit snugly into their respective slotted holes.



NOTE:

In the diagram below the bracket is already installed on the wall.

PPC-37xx-N270 Panel PC

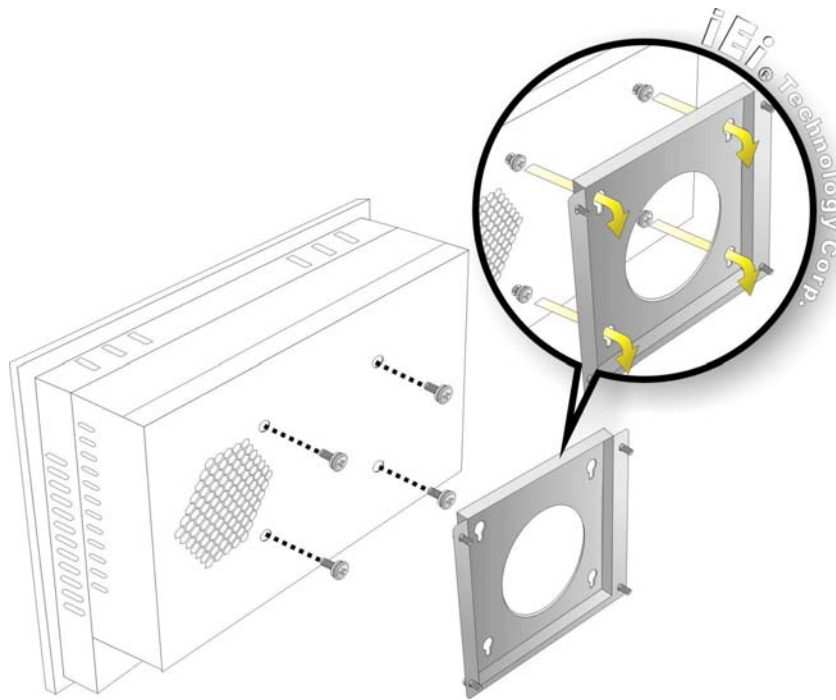

Figure 4-20: Mount the Chassis

Step 9: Secure the panel PC with the wall-mounting kit. To do this, stick the protective cushion to the wall-mounting kit first. Then, put the wall-mounting kit on the top panel of the panel PC. Carefully mark the location of the wall-mounting kit screw holes on the wall. Drill a pilot hole at the marked location on the wall. Secure the wall-mounting kit to the wall by inserting a retention screw into the pilot hole on the wall (**Figure 4-21**). This step is to avoid the panel PC being pushed apart from the wall-mounting bracket accidentally.

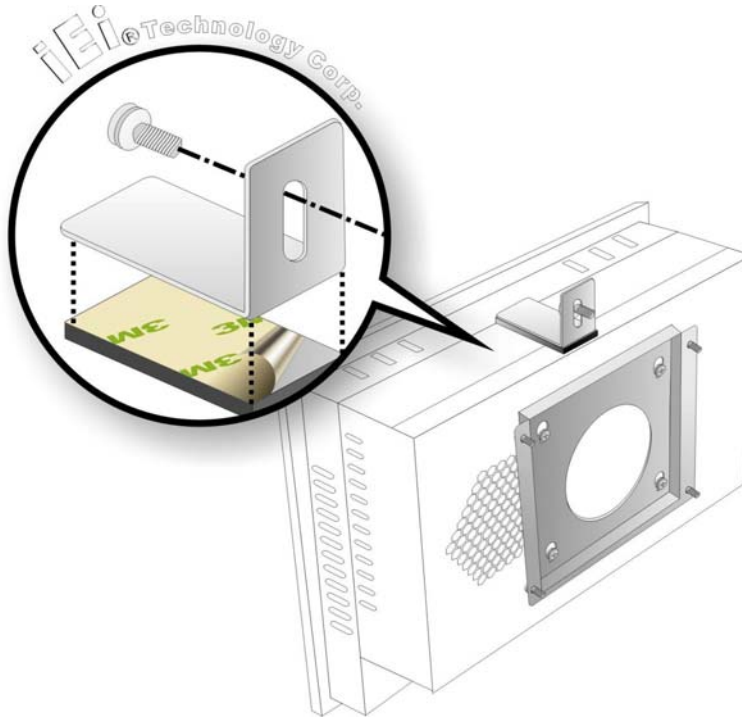

Figure 4-21: Secure the Chassis

4.11.2 Panel Mounting

4.11.2.1 PPC-3708A-N270 and PPC-3710A-N270

To mount the PPC-3708A-N270 or PPC-3710A-N270 flat panel PC into a panel, please follow the steps below.

- Step 1:** Select the position in the panel to mount the panel PC.
- Step 2:** Cut out a section from the panel that corresponds to the dimensions of the flat panel PC chassis. The panel section that is cut out must be smaller than the size of the aluminum frame that surrounds the TFT LCD panel but just large enough for the chassis to fit through. Refer to **Figure 4-22** and **Figure 4-23** for the suggested cut out size.

PPC-37xx-N270 Panel PC

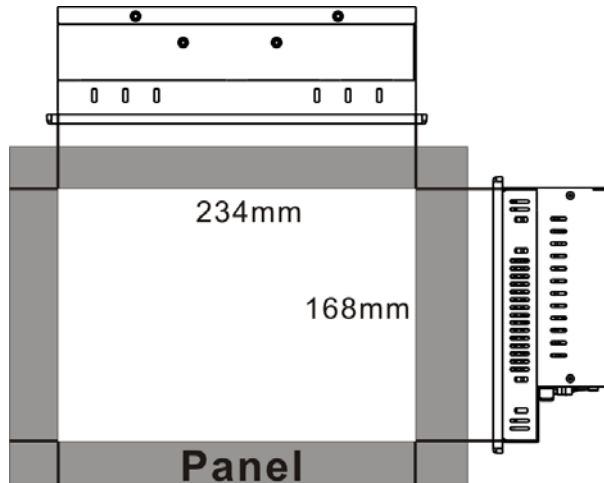

Figure 4-22: Suggested Panel Cut Out Size for PPC-3708A-N270

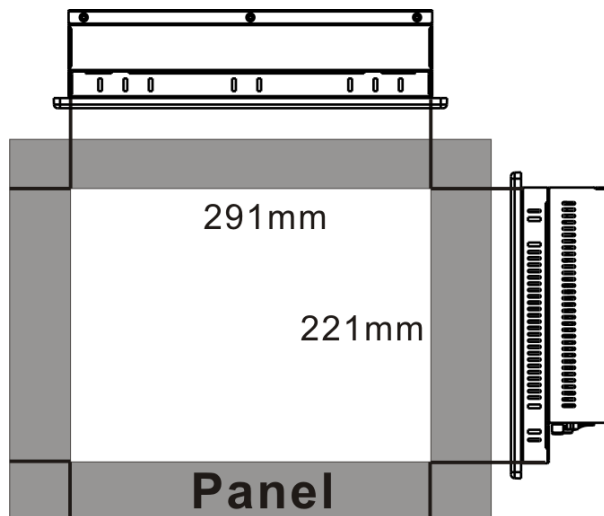

Figure 4-23: Suggested Panel Cut Out Size for PPC-3710A-N270

- Step 3:** Slide the flat panel computer through the previously cut hole. The chassis at the rear of the flat panel computer should slide easily through the hole. Only stop sliding the panel through the hole when the back of the front aluminum frame is flush against the panel.
- Step 4:** Insert the panel mounting clamps into the pre-formed holes along the edges of the chassis, behind the aluminum frame. There are a total of 8 panel mounting clamps for PPC-3708A-N270 and 10 clamps for PPC-3710A-N270.

Step 5: Tighten the screws that pass through the panel mounting clamps until the plastic caps at the front of all the screws are firmly secured to the panel (**Figure 4-24**).

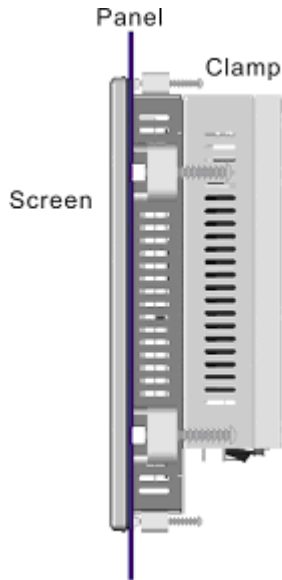

Figure 4-24: Tighten the Panel Mounting Clamp Screws

4.11.2.2 PPC-3712A-N270

To mount the PPC-3712A-N270 flat panel PC into a panel, please follow the steps below.

Step 1: Install the panel mounting kit onto the real panel (**Figure 4-25**).

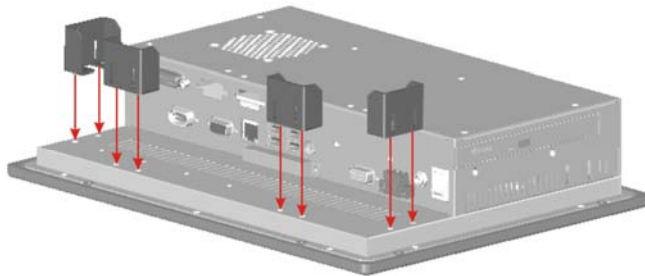

Figure 4-25: PPC-3712 Panel Mounting Kit

Step 2: Select the position in the panel to mount the PPC-3712A-N270.

PPC-37xx-N270 Panel PC

- Step 3:** Cut out a section from the panel that corresponds to the dimensions of the flat panel PC chassis. The panel section that is cut out must be smaller than the size of the aluminum frame that surrounds the 12.1" TFT LCD panel but just large enough for the chassis to fit through (**Figure 4-26**).

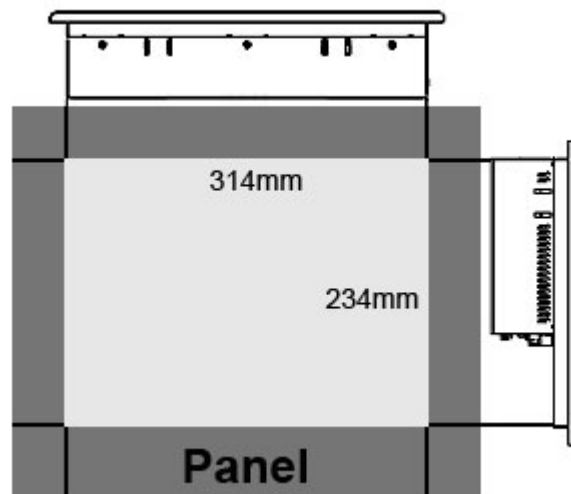

Figure 4-26: Suggested Panel Cut Out Size for PPC-3712A-N270

- Step 4:** Slide the panel PC through the hole until the aluminum frame is flush against the panel.
- Step 5:** Insert the panel mounting clamps into the pre-formed holes along the edges of the chassis, behind the aluminum frame. There are a total of 8 panel mounting clamps.
- Step 6:** Tighten the screws that pass through the panel mounting clamps until the plastic caps at the front of all the screws are firmly secured to the panel (**Figure 4-27**).

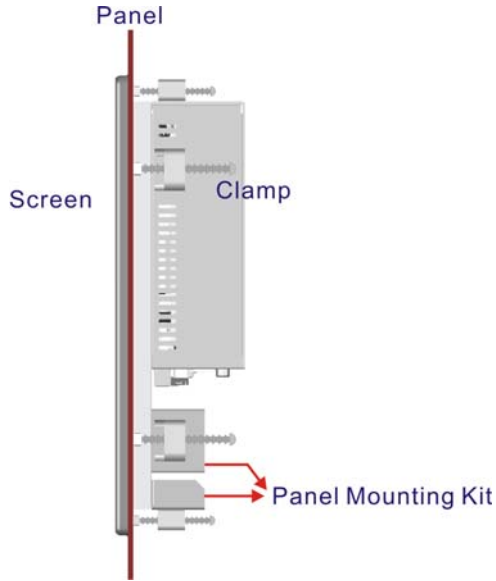

Figure 4-27: Tighten the Panel Mounting Clamp Screws

4.11.3 Arm Mounting

The flat panel PC is VESA (Video Electronics Standards Association) compliant and can be mounted on an arm with a 100 mm interface pad. To mount the flat panel PC on an arm, please follow the steps below.

Step 1: The arm is a separately purchased item. Please correctly mount the arm onto the surface it uses as a base. To do this, refer to the installation documentation that came with the mounting arm.



NOTE:

When purchasing the arm please ensure that it is VESA compliant and that the arm has a 100 mm interface pad. If the mounting arm is not VESA compliant it cannot be used to support the flat panel PC.

Step 2: Once the mounting arm has been firmly attached to the surface, lift the flat panel PC onto the interface pad of the mounting arm.

PPC-37xx-N270 Panel PC

Step 3: Align the retention screw holes on the mounting arm interface with those in the flat panel PC. The arm mount retention screw holes are shown in **Figure 4-28**.

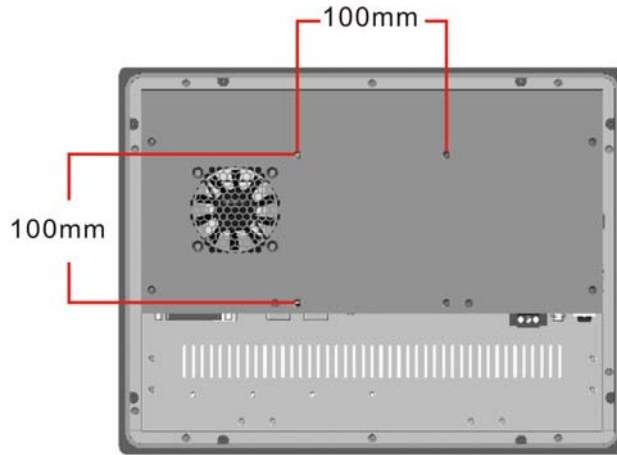

Figure 4-28: Arm Mounting Retention Screw Holes

Step 4: Secure the flat panel PC to the interface pad by inserting four retention screws through the bottom of the mounting arm interface pad and into the flat panel PC.

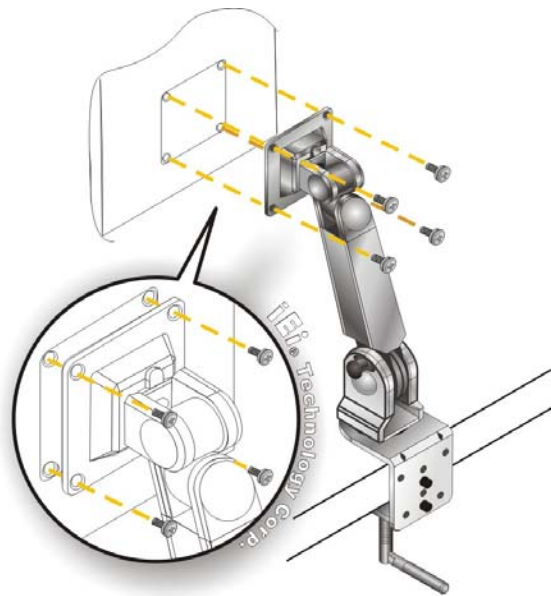

Figure 4-29: Arm Mounting

4.11.4 Cabinet and Rack Installation

The PPC-3708A-N270, PPC-3710A-N270 and PPC-3712A-N270 flat panel PC can be installed into a cabinet or rack. To do this, please follow the steps below.

4.11.4.1 PPC-3708A-N270

Step 1: Slide the rear chassis of the PPC-3708A-N270 flat panel PC through the rack/cabinet bracket until the aluminum frame is flush against the front of the bracket (**Figure 4-30**).

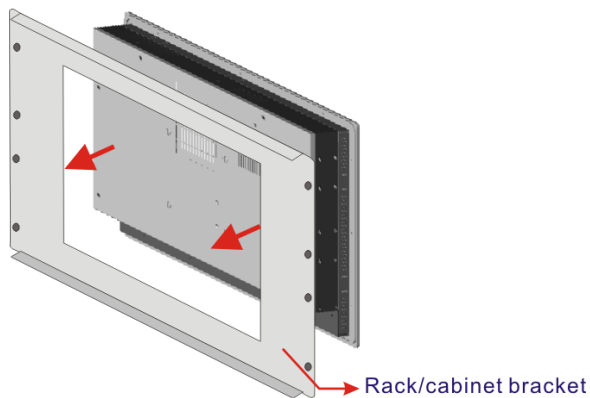

Figure 4-30: The Rack/Cabinet Bracket

Step 2: Insert the rack mounting clamps into the pre-formed holes along the edges of the PPC-3708A-N270, behind the metal frame. The required number of mounting clamps should be eight.

Step 3: Tighten the screws that pass through the rack mounting clamps until the plastic caps at the front of all the screws are firmly secured to the bracket (**Figure 4-31**).

PPC-37xx-N270 Panel PC

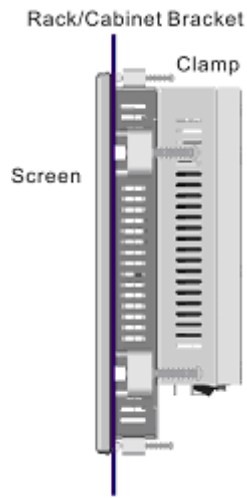

Figure 4-31: Secure the PPC-3708A-N270 Rack/Cabinet Bracket

Step 4: Slide the PPC-3708A-N270 flat panel PC with the attached rack/cabinet bracket into a rack or cabinet (**Figure 4-32**).

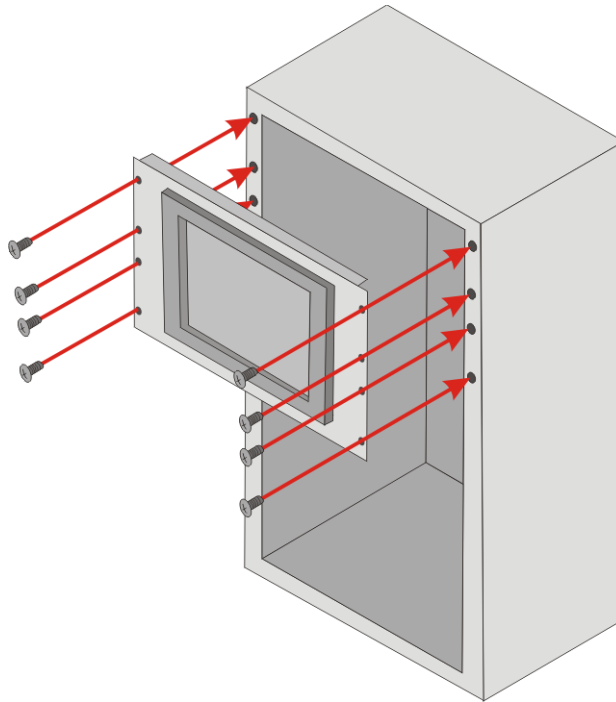

Figure 4-32: Install into a Rack/Cabinet

Step 5: Once the flat panel PC with the attached rack/cabinet bracket has been properly inserted into the rack or cabinet, secure the front of the rack/cabinet bracket to the front of the rack or cabinet (**Figure 4-32**).

4.11.4.2 PPC-3710A-N270 and PPC-3712A-N270

Step 1: The back of the aluminum frame surrounding the LCD screen has retention screw holes (PPC-3710A-N270 has 10 holes and PPC-3712A-N270 has 8 holes) for a cabinet/rack installation bracket.



NOTE:

When purchasing the cabinet/rack installation bracket make sure it is compatible with both the flat panel PC and the rack/cabinet into which the panel PC is installed.

Step 2: Slide the rear chassis through the rack/cabinet bracket until the rear side of the LCD screen frame is flush against the front of the bracket.

Step 3: Make sure the retention screw holes at the rear of the LCD screen are aligned with the retention screw holes in the rack/cabinet bracket.

Step 4: Secure the rack/cabinet bracket to the PPC-3712A-N270 flat panel PC by inserting the retention screws (**Figure 4-33**).

PPC-37xx-N270 Panel PC

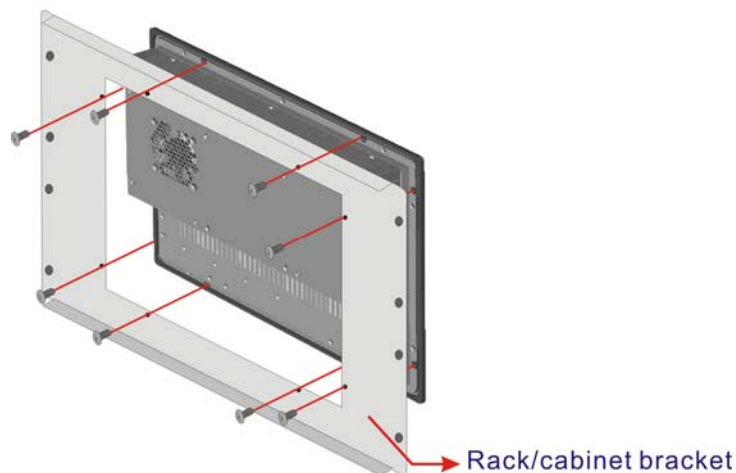

Figure 4-33: Secure the Rack/Cabinet Bracket

Step 5: Follow **Step 4** and **Step 5** of the PPC-3708A-N270 Cabinet and Rack Installation procedures to complete the whole installation process.

4.12 Rear Panel Connectors

4.12.1 Keyboard and Mouse Connection

Two PS/2 connectors on the bottom panel facilitate the connection of a mouse and a keyboard. To connect either device, plug the PS/2 connector at the end of the device (keyboard or mouse) cable into the PS/2 connector on the bottom panel.

4.12.2 LAN Connection

There are two external RJ-45 LAN connectors. The RJ-45 connectors enable connection to an external network. To connect a LAN cable with an RJ-45 connector, please follow the instructions below.

Step 1: **Locate the RJ-45 connectors** on the bottom panel of the PPC-37xx-N270.

Step 2: **Align the connectors.** Align the RJ-45 connector on the LAN cable with one of the RJ-45 connectors on the bottom panel of the PPC-37xx-N270. See

Figure 4-34.

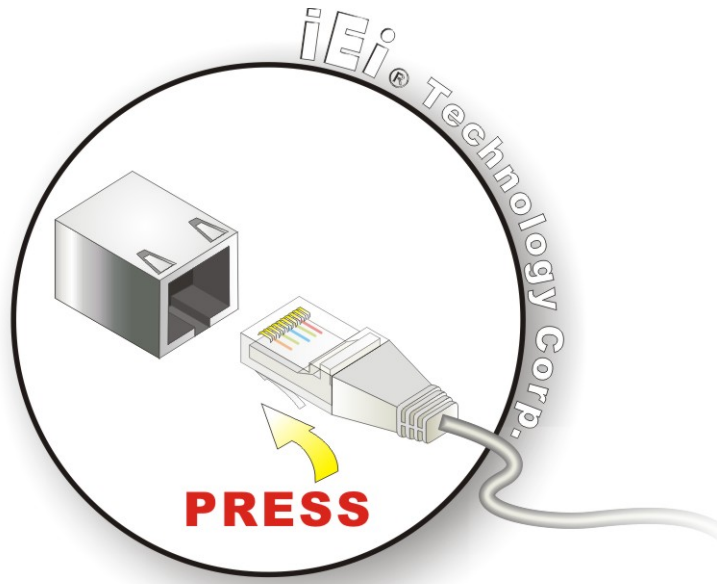

Figure 4-34: LAN Connection

Step 3: Insert the LAN cable RJ-45 connector. Once aligned, gently insert the LAN cable RJ-45 connector into the onboard RJ-45 connector.

4.12.3 Serial Device Connection

The PPC-37xx-N270 has three single male DB-9 connectors on the bottom panel for serial device connection. Follow the steps below to connect a serial device to the PPC-37xx-N270 panel PC.

Step 1: Locate the DB-9 connector. The location of the DB-9 connector is shown in Chapter 2.

Step 2: Insert the serial connector. Insert the DB-9 connector of a serial device into the DB-9 connector on the bottom panel. See **Figure 4-35**.

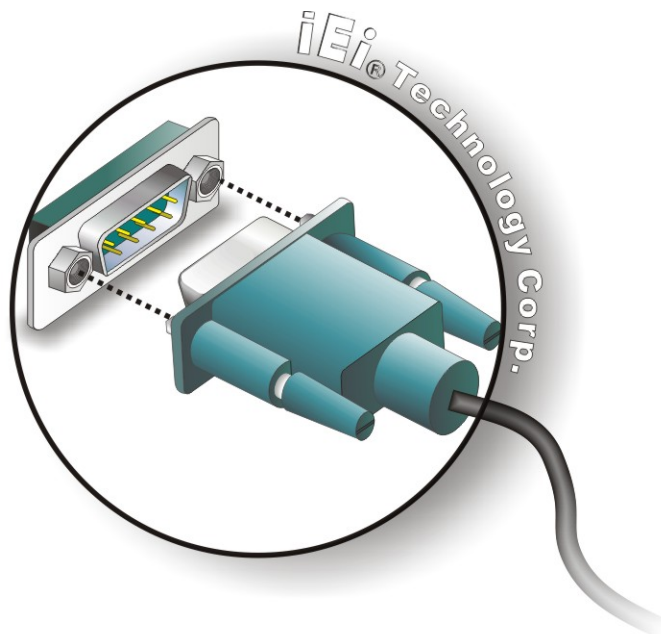

Figure 4-35: Serial Device Connector

Step 3: **Secure the connector.** Secure the serial device connector to the external interface by tightening the two retention screws on either side of the connector.

4.12.4 USB Device Connection

To connect a USB 2.0 or USB 1.1 device, please follow the instructions below.

Step 1: **Locate the USB connectors.** The locations of the USB connectors are shown in **Chapter 2**.

Step 2: **Align the connectors.** Align the USB device connector with one of the connectors on the bottom panel. See **Figure 4-36**.

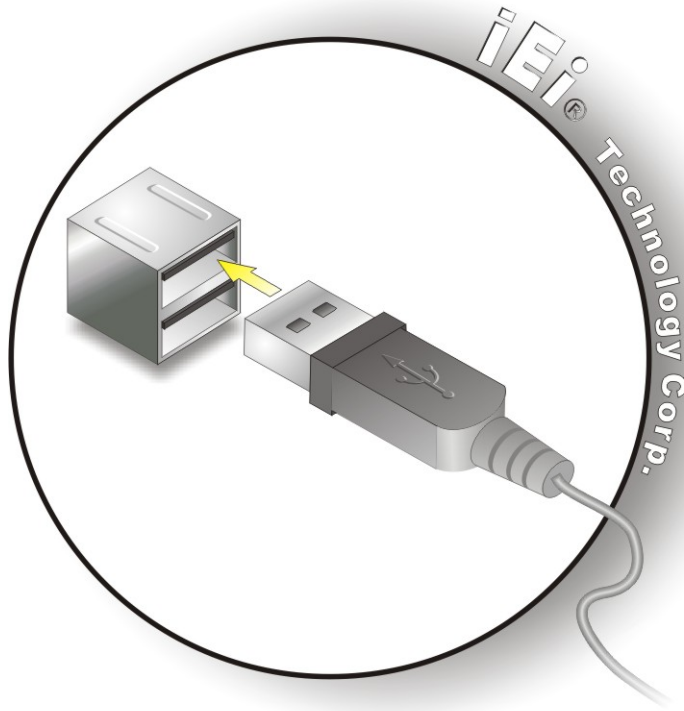

Figure 4-36: USB Device Connection

Step 3: Insert the device connector. Once aligned, gently insert the USB device connector into the onboard connector.

4.12.5 VGA Monitor Connection

The PPC-37xx-N270 has a single female DB-15 connector on the external peripheral interface panel. The DB-15 connector is connected to a CRT or VGA monitor. To connect a monitor to the PPC-37xx-N270, please follow the instructions below.

Step 1: Locate the female DB-15 connector. The location of the female DB-15 connector is shown in **Chapter 3**.

Step 2: Align the VGA connector. Align the male DB-15 connector on the VGA screen cable with the female DB-15 connector on the external peripheral interface.

PPC-37xx-N270 Panel PC

Step 3: Insert the VGA connector Once the connectors are properly aligned with the insert the male connector from the VGA screen into the female connector on the PPC-37xx-N270. See **Figure 4-37**.

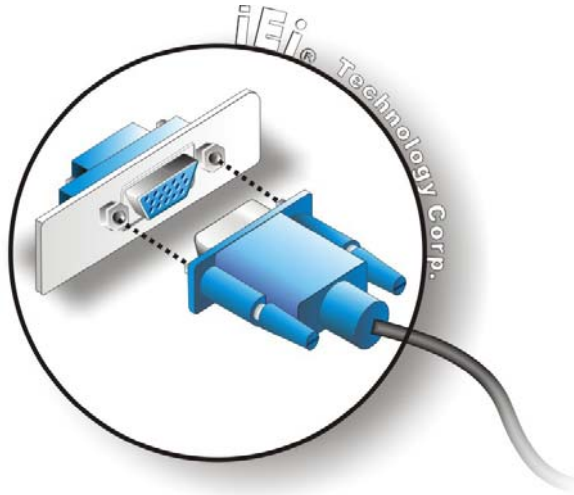

Figure 4-37: VGA Connector

Step 4: Secure the connector. Secure the DB-15 VGA connector from the VGA monitor to the external interface by tightening the two retention screws on either side of the connector.

4.13 System Maintenance

If the components of the flat panel PC fail, they must be replaced. Please contact the system reseller or vendor to purchase the replacement parts. Replacement instructions for the above listed components are described below.



NOTE:

A user cannot replace a motherboard. If the motherboard fails it must be shipped back to IEI to be replaced. Please contact the system vendor, reseller or an IEI sales person directly.

Chapter

5

BIOS Screens

5.1 Introduction

A licensed copy of AMI BIOS is preprogrammed into the ROM BIOS. The BIOS setup program allows users to modify the basic system configuration. This chapter describes how to access the BIOS setup program and the configuration options that may be changed.

5.1.1 Starting Setup

The AMI BIOS is activated when the computer is turned on. The setup program can be activated in one of two ways.

1. Press the **DELETE** key as soon as the system is turned on or
2. Press the **DELETE** key when the “**Press Del to enter SETUP**” message appears on the screen.

If the message disappears before the **DELETE** key is pressed, restart the computer and try again.

5.1.2 Using Setup

Use the arrow keys to highlight items, press **ENTER** to select, use the PageUp and PageDown keys to change entries, press **F1** for help and press **Esc** to quit. Navigation keys are shown in.

Key	Function
Up arrow	Move to previous item
Down arrow	Move to next item
Left arrow	Move to the item on the left hand side
Right arrow	Move to the item on the right hand side
Esc key	Main Menu – Quit and not save changes into CMOS Status Page Setup Menu and Option Page Setup Menu -- Exit current page and return to Main Menu
Page Up key	Increase the numeric value or make changes
Page Dn key	Decrease the numeric value or make changes

F1 key	General help, only for Status Page Setup Menu and Option Page Setup Menu
F2 /F3 key	Change color from total three colors. F2 to select color forward.
F10 key	Save all the CMOS changes, only for Main Menu

Table 5-1: BIOS Navigation Keys

5.1.3 Getting Help

When **F1** is pressed a small help window describing the appropriate keys to use and the possible selections for the highlighted item appears. To exit the Help Window press **Esc** or the **F1** key again.

5.1.4 Unable to Reboot After Configuration Changes

If the computer cannot boot after changes to the system configuration is made, CMOS defaults. Use the jumper described in **Chapter 5**.

5.1.5 BIOS Menu Bar

The **menu bar** on top of the BIOS screen has the following main items:

- **Main** Changes the basic system configuration.
- **Advanced** Changes the advanced system settings.
- **PCIPnP** Changes the advanced PCI/PnP Settings
- **Boot** Changes the system boot configuration.
- **Security** Sets User and Supervisor Passwords.
- **Chipset** Changes the chipset settings.
- **Power** Changes power management settings.
- **Exit** Selects exit options and loads default settings

The following sections completely describe the configuration options found in the menu items at the top of the BIOS screen and listed above.

PPC-37xx-N270 Panel PC

5.2 Main

The **Main** BIOS menu (**BIOS Menu 1**) appears when the **BIOS Setup** program is entered. The **Main** menu gives an overview of the basic system information.

BIOS SETUP UTILITY	
Main	Advanced PCIPnP Boot Security Chipset Power Exit
<pre> System Overview ----- AMIBIOS Version :08.00.15 Build Date:08/28/08 ID :B113MR17 Processor Type :Intel® Atom (TM) CPU N270 @ 1.60GHz Speed :1600MHz Count :1 System Memory Size :1016MB System Time [14:20:27] System Date [Tue 05/06/2008] </pre>	<pre> Use [ENTER], [TAB] or [SHIFT-TAB] to select a field. Use [+] or [-] to configure system Time. ←→ Select Screen ↑↓ Select Item +- Change Field Tab Select Field F1 General Help F10 Save and Exit ESC Exit </pre>
v02.59 (C) Copyright 1985-2005, American Megatrends, Inc.	

BIOS Menu 1: Main

→ System Overview

The **System Overview** lists a brief summary of different system components. The fields in **System Overview** cannot be changed. The items shown in the system overview include:

- **AMI BIOS:** Displays auto-detected BIOS information
 - Version: Current BIOS version
 - Build Date: Date the current BIOS version was made
 - ID: Installed BIOS ID
- **Processor:** Displays auto-detected CPU specifications
 - Type: Names the currently installed processor
 - Speed: Lists the processor speed
 - Count: The number of CPUs on the motherboard

- **System Memory:** Displays the auto-detected system memory.
 - Size: Lists memory size

The **System Overview** field also has two user configurable fields:

→ **System Time [xx:xx:xx]**

Use the **System Time** option to set the system time. Manually enter the hours, minutes and seconds.

→ **System Date [xx/xx/xx]**

Use the **System Date** option to set the system date. Manually enter the day, month and year.

5.3 Advanced

Use the **Advanced** menu (**BIOS Menu 2**) to configure the CPU and peripheral devices through the following sub-menus:



WARNING:

Setting the wrong values in the sections below may cause the system to malfunction. Make sure that the settings made are compatible with the hardware.

- CPU Configuration (see **Section 5.3.1**)
- IDE Configuration (see **Section 5.3.2**)
- SuperIO Configuration (see **Section 5.3.3**)
- Hardware Health Configuration (see **Section 5.3.4**)
- Power Configuration (see **Section 5.3.5**)
- Remote Access Configuration (see **Section 5.3.6**)
- USB Configuration (see **Section 5.3.7**)

PPC-37xx-N270 Panel PC

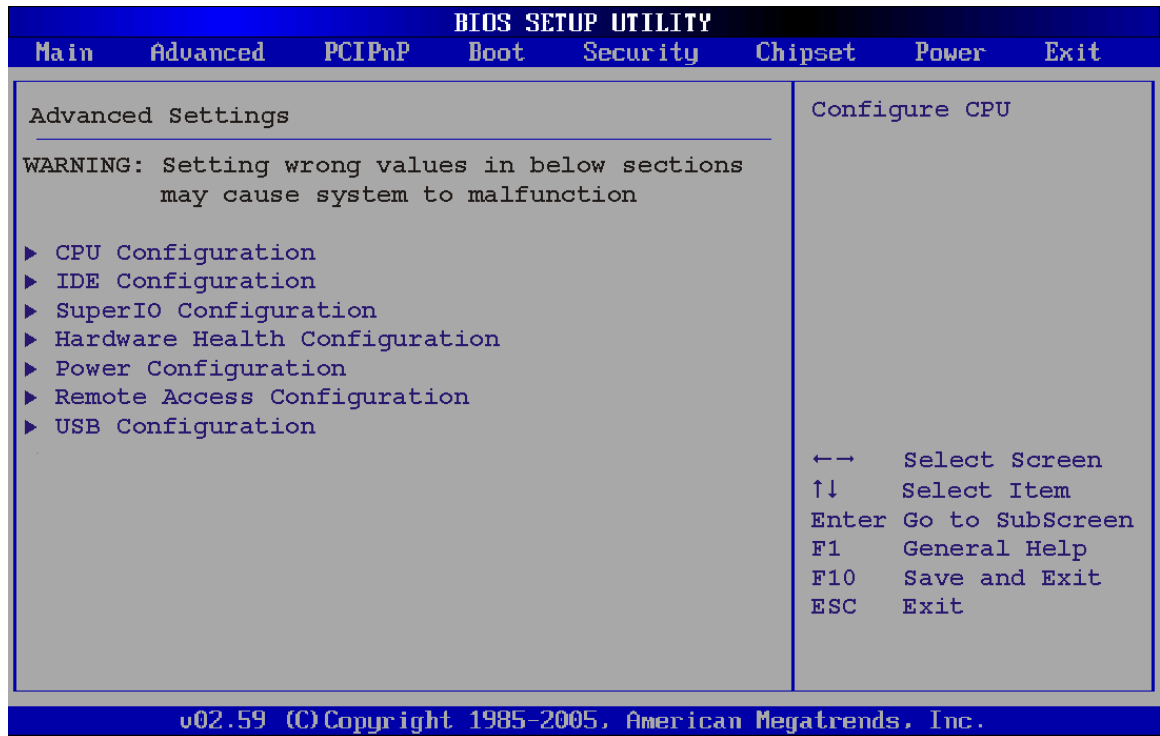
**BIOS Menu 2: Advanced****5.3.1 CPU Configuration**

Use the **CPU Configuration** menu (**BIOS Menu 3**) to view detailed CPU specifications and configure the CPU.

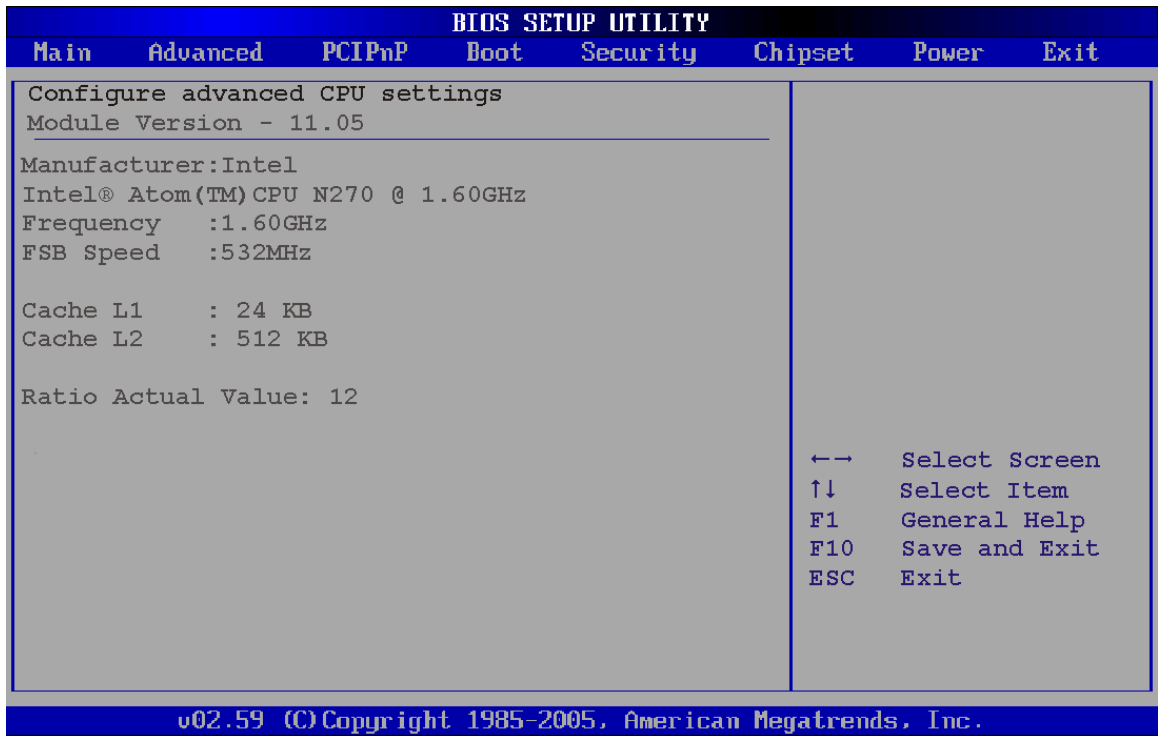

BIOS Menu 3: CPU Configuration

The CPU Configuration menu (BIOS Menu 3) lists the following CPU details:

- **Manufacturer:** Lists the name of the CPU manufacturer
- **Brand String:** Lists the brand name of the CPU being used
- **Frequency:** Lists the CPU processing speed
- **FSB Speed:** Lists the FSB speed
- **Cache L1:** Lists the CPU L1 cache size
- **Cache L2:** Lists the CPU L2 cache size

5.3.2 IDE Configuration

Use the **IDE Configuration** menu (**BIOS Menu 4**) to change and/or set the configuration of the IDE devices installed in the system.

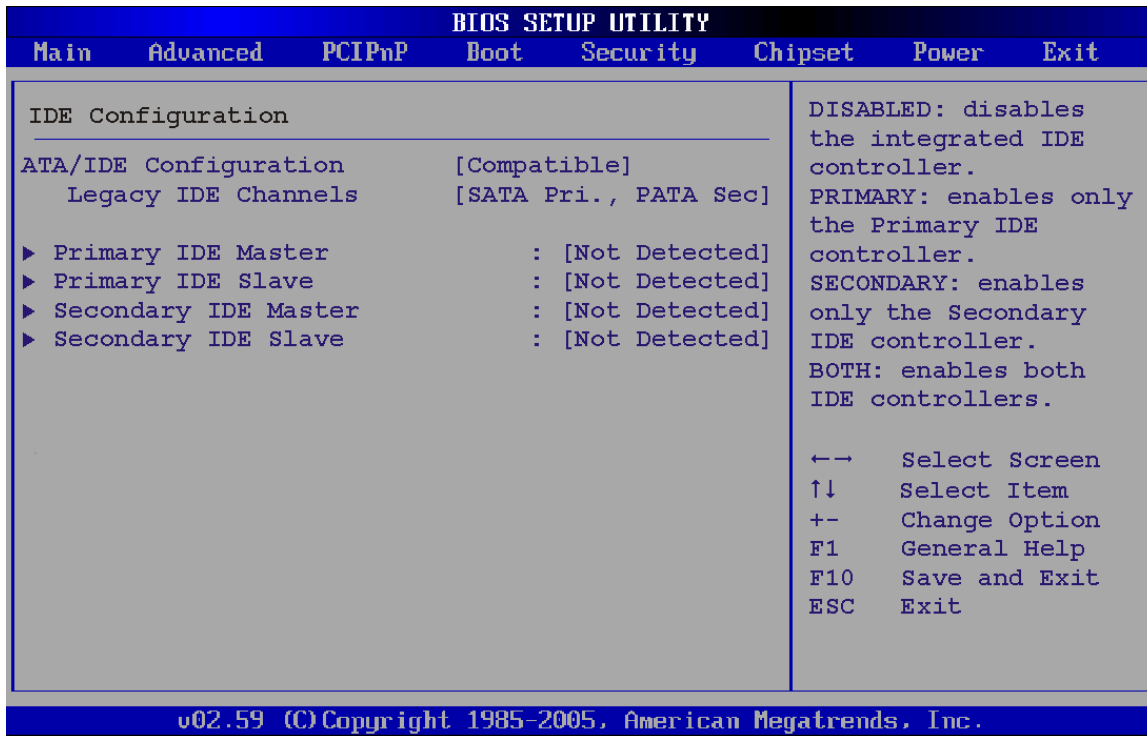

BIOS Menu 4: IDE Configuration

➔ **ATA/IDE Configurations [Compatible]**

Use the **ATA/IDE Configurations** option to configure the ATA/IDE controller.

- ➔ **Disabled** Disables the on-board ATA/IDE controller.
- ➔ **Compatible** Configures the on-board ATA/IDE controller to be in compatible mode. In this mode, a SATA channel will replace one of the IDE channels. This mode supports up to 4 storage devices.
- ➔ **Enhanced DEFAULT** Configures the on-board ATA/IDE controller to be in Enhanced mode. In this mode, IDE channels and SATA channels are separated. This mode supports up to 6 storage devices. Some legacy OS do not support this mode.

➔ **Legacy IDE Channels [PATA Pri, SATA Sec]**

- | | | | |
|---|---------------------------|----------------|--|
| → | SATA Only | | Only the SATA drives are enabled. |
| → | SATA Pri, PATA Sec | DEFAULT | The IDE drives are enabled on the Primary IDE channel. The SATA drives are enabled on the Secondary IDE channel. |
| → | PATA Only | | The IDE drives are enabled on the primary and secondary IDE channels. SATA drives are disabled. |

→ IDE Master and IDE Slave

When entering setup, BIOS auto detects the presence of IDE devices. BIOS displays the status of the auto detected IDE devices. The following IDE devices are detected and are shown in the **IDE Configuration** menu:

- Primary IDE Master
- Primary IDE Slave
- Secondary IDE Master
- Secondary IDE Slave

The **IDE Configuration** menu (**BIOS Menu 4**) allows changes to the configurations for the IDE devices installed in the system. If an IDE device is detected, and one of the above listed four BIOS configuration options are selected, the IDE configuration options shown in **Section 5.3.2.1** appear.

5.3.2.1 IDE Master, IDE Slave

Use the **IDE Master** and **IDE Slave** configuration menu to view both primary and secondary IDE device details and configure the IDE devices connected to the system.

PPC-37xx-N270 Panel PC

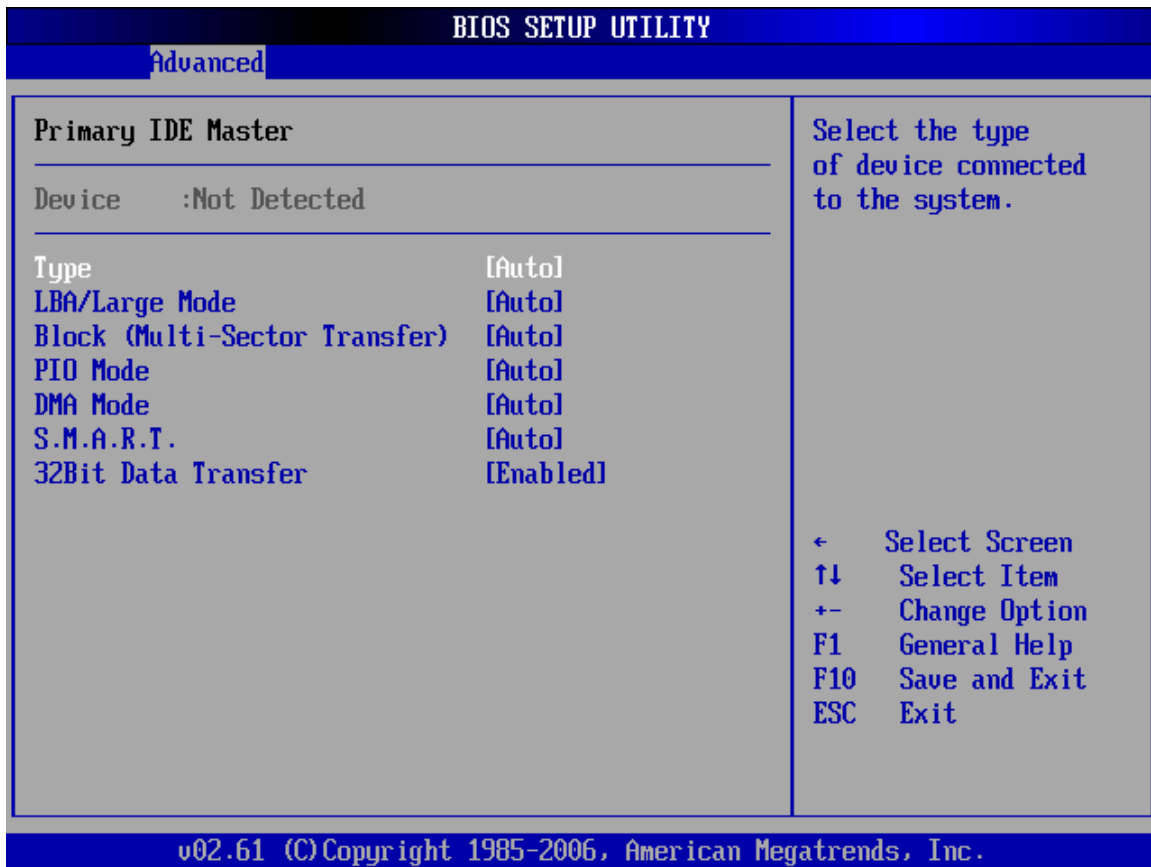

BIOS Menu 5: IDE Master and IDE Slave Configuration

→ Auto-Detected Drive Parameters

The "grayed-out" items in the left frame are IDE disk drive parameters automatically detected from the firmware of the selected IDE disk drive. The drive parameters are listed as follows:

- **Device:** Lists the device type (e.g. hard disk, CD-ROM etc.)
- **Type:** Indicates the type of devices a user can manually select
- **Vendor:** Lists the device manufacturer
- **Size:** List the storage capacity of the device.
- **LBA Mode:** Indicates whether the LBA (Logical Block Addressing) is a method of addressing data on a disk drive is supported or not.
- **Block Mode:** Block mode boosts IDE drive performance by increasing the amount of data transferred. Only 512 bytes of data can be transferred per

interrupt if block mode is not used. Block mode allows transfers of up to 64 KB per interrupt.

- **PIO Mode:** Indicates the PIO mode of the installed device.
- **Async DMA:** Indicates the highest Asynchronous DMA Mode that is supported.
- **Ultra DMA:** Indicates the highest Synchronous DMA Mode that is supported.
- **S.M.A.R.T.:** Indicates whether or not the Self-Monitoring Analysis and Reporting Technology protocol is supported.
- **32Bit Data Transfer:** Enables 32-bit data transfer.

→ **Type [Auto]**

Use the **Type** BIOS option select the type of device the AMIBIOS attempts to boot from after the Power-On Self-Test (POST) is complete.

- **Not Installed** BIOS is prevented from searching for an IDE disk drive on the specified channel.
- **Auto** **DEFAULT** The BIOS auto detects the IDE disk drive type attached to the specified channel. This setting should be used if an IDE hard disk drive is attached to the specified channel.
- **CD/DVD** The CD/DVD option specifies that an IDE CD-ROM drive is attached to the specified IDE channel. The BIOS does not attempt to search for other types of IDE disk drives on the specified channel.
- **ARMD** This option specifies an ATAPI Removable Media Device. These include, but are not limited to:

→ **ZIP**

→ **LS-120**

→ **LBA/Large Mode [Auto]**

PPC-37xx-N270 Panel PC

Use the **LBA/Large Mode** option to disable or enable BIOS to auto detects LBA (Logical Block Addressing). LBA is a method of addressing data on a disk drive. In LBA mode, the maximum drive capacity is 137 GB.

- ➔ **Disabled** BIOS is prevented from using the LBA mode control on the specified channel.
- ➔ **Auto** **DEFAULT** BIOS auto detects the LBA mode control on the specified channel.

➔ **Block (Multi Sector Transfer) [Auto]**

Use the **Block (Multi Sector Transfer)** to disable or enable BIOS to auto detect if the device supports multi-sector transfers.

- ➔ **Disabled** BIOS is prevented from using Multi-Sector Transfer on the specified channel. The data to and from the device occurs one sector at a time.
- ➔ **Auto** **DEFAULT** BIOS auto detects Multi-Sector Transfer support on the drive on the specified channel. If supported the data transfer to and from the device occurs multiple sectors at a time.

➔ **PIO Mode [Auto]**

Use the **PIO Mode** option to select the IDE PIO (Programmable I/O) mode program timing cycles between the IDE drive and the programmable IDE controller. As the PIO mode increases, the cycle time decreases.

- ➔ **Auto** **DEFAULT** BIOS auto detects the PIO mode. Use this value if the IDE disk drive support cannot be determined.
- ➔ **0** PIO mode 0 selected with a maximum transfer rate of 3.3MBps
- ➔ **1** PIO mode 1 selected with a maximum transfer rate of 5.2MBps
- ➔ **2** PIO mode 2 selected with a maximum transfer rate of 8.3MBps
- ➔ **3** PIO mode 3 selected with a maximum transfer rate of 11.1MBps

→ 4 PIO mode 4 selected with a maximum transfer rate of 16.6MBps
 (This setting generally works with all hard disk drives manufactured after 1999. For other disk drives, such as IDE CD-ROM drives, check the specifications of the drive.)

→ **DMA Mode [Auto]**

Use the **DMA Mode** BIOS selection to adjust the DMA mode options.

- **Auto** **DEFAULT** BIOS auto detects the DMA mode. Use this value if the IDE disk drive support cannot be determined.
- **SWDMA0** Single Word DMA mode 0 selected with a maximum data transfer rate of 2.1MBps
- **SWDMA1** Single Word DMA mode 1 selected with a maximum data transfer rate of 4.2MBps
- **SWDMA2** Single Word DMA mode 2 selected with a maximum data transfer rate of 8.3MBps
- **MWDMA0** Multi Word DMA mode 0 selected with a maximum data transfer rate of 4.2MBps
- **MWDMA1** Multi Word DMA mode 1 selected with a maximum data transfer rate of 13.3MBps
- **MWDMA2** Multi Word DMA mode 2 selected with a maximum data transfer rate of 16.6MBps
- **UDMA1** Ultra DMA mode 0 selected with a maximum data transfer rate of 16.6MBps
- **UDMA1** Ultra DMA mode 1 selected with a maximum data transfer rate of 25MBps
- **UDMA2** Ultra DMA mode 2 selected with a maximum data transfer rate of 33.3MBps
- **UDMA3** Ultra DMA mode 3 selected with a maximum data transfer rate of 44MBps (To use this mode, it is required that an

PPC-37xx-N270 Panel PC

80-conductor ATA cable is used.)

→ **UDMA4**

Ultra DMA mode 4 selected with a maximum data transfer rate of 66.6MBps (To use this mode, it is required that an 80-conductor ATA cable is used.)

→ **UDMA5**

Ultra DMA mode 5 selected with a maximum data transfer rate of 99.9MBps (To use this mode, it is required that an 80-conductor ATA cable is used.)

→ **S.M.A.R.T [Auto]**

Use the **S.M.A.R.T** option to auto-detect, disable or enable Self-Monitoring Analysis and Reporting Technology (SMART) on the drive on the specified channel. **S.M.A.R.T** predicts impending drive failures. The **S.M.A.R.T** BIOS option enables or disables this function.

→ **Auto** **DEFAULT** BIOS auto detects HDD SMART support.

→ **Disabled** Prevents BIOS from using the HDD SMART feature.

→ **Enabled** Allows BIOS to use the HDD SMART feature

→ **32Bit Data Transfer [Enabled]**

Use the **32Bit Data Transfer** BIOS option to enables or disable 32-bit data transfers.

→ **Disabled** Prevents the BIOS from using 32-bit data transfers.

→ **Enabled** **DEFAULT** Allows BIOS to use 32-bit data transfers on supported hard disk drives.

5.3.3 Super IO Configuration

Use the **Super IO Configuration** menu (**BIOS Menu 6**) to set or change the configurations for the FDD controllers, parallel ports and serial ports.

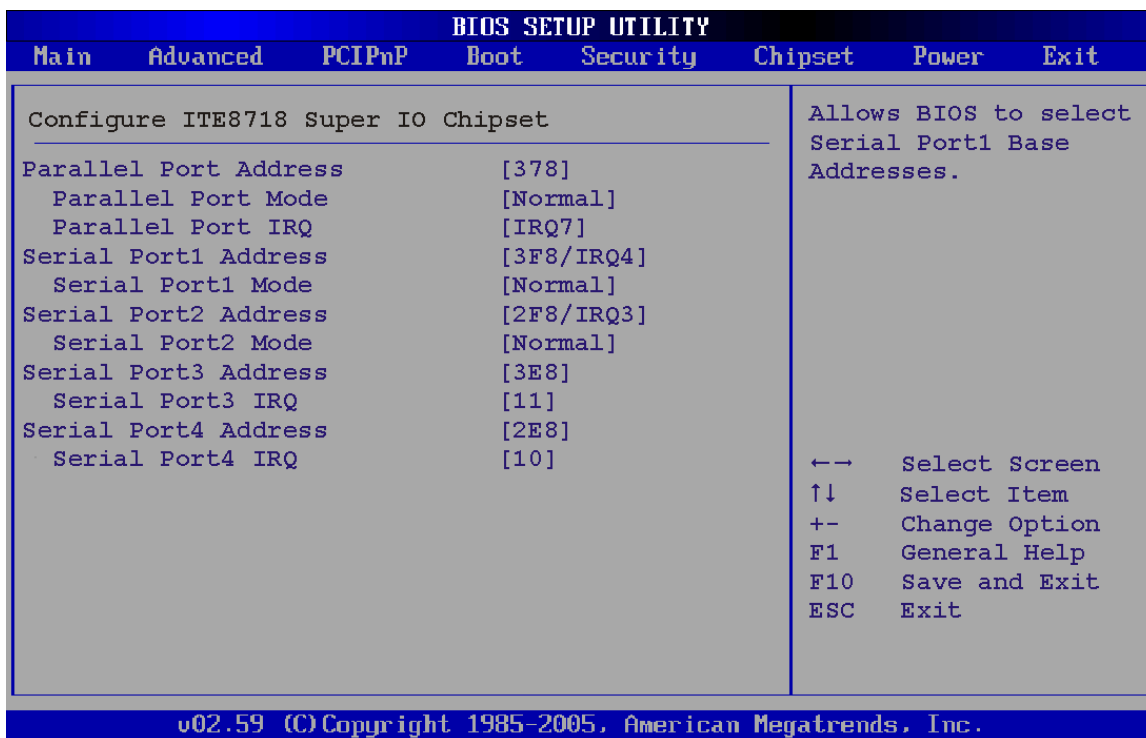

BIOS Menu 6: Super IO Configuration

→ Parallel Port Address [Disabled]

Use the **Parallel Port Address** option to select the parallel port base address.

- **Disabled** **DEFAULT** No base address is assigned to the Parallel Port
- **378** Parallel Port I/O port address is 378
- **278** Parallel Port I/O port address is 278
- **3BC** Parallel Port I/O port address is 3BC

→ Parallel Port Mode [Normal]

Use the **Parallel Port Mode** option to select the mode the parallel port operates in.

- **Normal** **DEFAULT** The normal parallel port mode is the standard mode for parallel port operation.
- **EPP** The parallel port operates in the enhanced parallel

port mode (EPP). The EPP mode supports bi-directional communication between the system and the parallel port device and the transmission rates between the two are much faster than the Normal mode.

→ **ECP+EPP**

The parallel port operates in the extended capabilities port (ECP) mode. The ECP mode supports bi-directional communication between the system and the parallel port device and the transmission rates between the two are much faster than the Normal mode

The parallel port is also be compatible with EPP devices described above

→ **Parallel Port IRQ [IRQ7]**

Use the **Parallel Port IRQ** selection to set the parallel port interrupt address.

- **IRQ5** IRQ5 is assigned as the parallel port interrupt address
- **IRQ7** **DEFAULT** IRQ7 is assigned as the parallel port interrupt address

→ **Serial Port1 Address [3F8/IRQ4]**

Use the **Serial Port1 Address** option to select the Serial Port 1 base address.

- **Disabled** No base address is assigned to Serial Port 1
- **3F8/IRQ4** **DEFAULT** Serial Port 1 I/O port address is 3F8 and the interrupt address is IRQ4
- **3E8/IRQ4** Serial Port 1 I/O port address is 3E8 and the interrupt address is IRQ4
- **2E8/IRQ3** Serial Port 1 I/O port address is 2E8 and the interrupt address is IRQ3

→ **Serial Port1 Mode [Normal]**

Use the **Serial Port1 Mode** option to select the transmitting and receiving mode for the first serial port.

- ➔ **Normal** **DEFAULT** Serial Port 1 mode is normal
- ➔ **IrDA** Serial Port 1 mode is IrDA
- ➔ **ASK IR** Serial Port 1 mode is ASK IR

➔ **Serial Port2 Address [2F8/IRQ3]**

Use the **Serial Port2 Address** option to select the Serial Port 2 base address.

- ➔ **Disabled** No base address is assigned to Serial Port 2
- ➔ **2F8/IRQ3** **DEFAULT** Serial Port 2 I/O port address is 3F8 and the interrupt address is IRQ3
- ➔ **3E8/IRQ4** Serial Port 2 I/O port address is 3E8 and the interrupt address is IRQ4
- ➔ **2E8/IRQ3** Serial Port 2 I/O port address is 2E8 and the interrupt address is IRQ3

➔ **Serial Port2 Mode [Normal]**

Use the **Serial Port2 Mode** option to select the Serial Port2 operational mode.

- ➔ **Normal** **DEFAULT** Serial Port 2 mode is normal
- ➔ **IrDA** Serial Port 2 mode is IrDA
- ➔ **ASK IR** Serial Port 2 mode is ASK IR

➔ **Serial Port3 Address [3E8]**

Use the **Serial Port3 Address** option to select the base addresses for serial port 3

- ➔ **Disabled** No base address is assigned to serial port 3
- ➔ **3E8** **DEFAULT** Serial port 3 I/O port address is 3E8
- ➔ **2E8** Serial port 3 I/O port address is 2E8

PPC-37xx-N270 Panel PC

- 2F0 Serial port 3 I/O port address is 2F0
- 2E0 Serial port 3 I/O port address is 2E0

→ Serial Port3 IRQ [11]

Use the **Serial Port3 IRQ** option to select the interrupt address for serial port 3.

- 10 Serial port 3 IRQ address is 10
- 11 **DEFAULT** Serial port 3 IRQ address is 11

→ Serial Port4 Address [2E8]

Use the **Serial Port4 IRQ** option to select the interrupt address for serial port 4.

- **Disabled** No base address is assigned to serial port 3
- 3E8 Serial port 4 I/O port address is 3E8
- 2E8 **DEFAULT** Serial port 4 I/O port address is 2E8
- 2F0 Serial port 4 I/O port address is 2F0
- 2E0 Serial port 4 I/O port address is 2E0

→ Serial Port4 IRQ [10]

Use the **Serial Port4 IRQ** option to select the interrupt address for serial port 4.

- 10 **DEFAULT** Serial port 4 IRQ address is 10
- 11 Serial port 4 IRQ address is 11

5.3.4 Hardware Health Configuration

The **Hardware Health Configuration** menu (**BIOS Menu 7**) shows the operating temperature, fan speeds and system voltages.

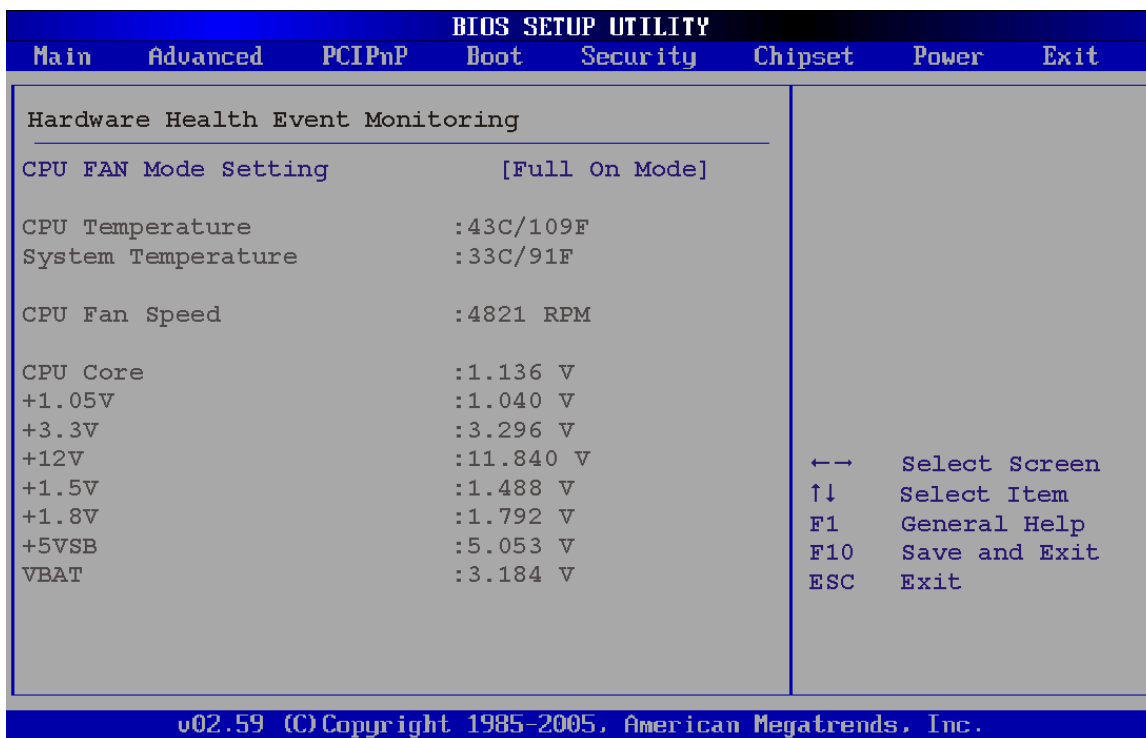

BIOS Menu 7: Hardware Health Configuration

→ CPU FAN Mode Setting [Full On Mode]

Use the **CPU FAN Mode Setting** option to configure the second fan.

- **Full On Mode** **DEFAULT** Fan is on all the time
- **Automatic mode** Fan is off when the temperature is low enough. Parameters must be set by the user.
- **PWM Manual mode** Pulse width modulation set manually

When the **CPU FAN Mode Setting** option is in the **Automatic Mode**, the following parameters can be set.

- CPU Temp. Limit of OFF
- CPU Temp. Limit of Start
- CPU Fan Start PWM
- Slope PWM 1

PPC-37xx-N270 Panel PC

When the **CPU FAN Mode Setting** option is in the **PWM Manual Mode**, the following parameters can be set.

- CPU Fan PWM control

→ CPU Temp. Limit of OFF [000]



WARNING:

Setting this value too high may cause the fan to stop when the CPU is at a high temperature and therefore cause the system to be damaged.

The **CPU Temp. Limit of OFF** option can only be set if the **CPU FAN Mode Setting** option is set to **Automatic Mode**. Use the **CPU Temp. Limit of OFF** option to select the CPU temperature at which the cooling fan should automatically turn off. To select a value, select the **CPU Temp. Limit of OFF** option and enter a decimal number between 000 and 127. The temperature range is specified below.

- Minimum Value: 0°C
- Maximum Value: 127°C

→ CPU Temp. Limit of Start [020]



WARNING:

Setting this value too high may cause the fan to start only when the CPU is at a high temperature and therefore cause the system to be damaged.

The **CPU Temp. Limit of Start** option can only be set if the **CPU FAN Mode Setting** option is set to **Automatic Mode**. Use the **CPU Temp. Limit of Start** option to select the CPU temperature at which the cooling fan should automatically turn on. When the fan starts, it rotates using the starting pulse width modulation (PWM) specified in the **Fan 3 Start PWM** option below. To select a value, select the **CPU Temp. Limit of Start** option

and enter a decimal number between 000 and 127. The temperature range is specified below.

- Minimum Value: 0°C
- Maximum Value: 127°C

→ CPU Fan Start PWM [070]

The **Fan 3 Start PWM** option can only be set if the **CPU FAN Mode Setting** option is set to **Automatic Mode**. Use the **Fan 3 Start PWM** option to select the PWM mode the fan starts to rotate with after the temperature specified in the **Temperature 3 Limit of Start** is exceeded. The Super I/O chipset supports 128 PWM modes. To select a value, select the **Fan 3 Start PWM** option and enter a decimal number between 000 and 127. The temperature range is specified below.

- PWM Minimum Mode: 0
- PWM Maximum Mode: 127

→ Slope PWM [0.5 PWM]

The **Slope PWM 1** option can only be set if the **CPU FAN Mode Setting** option is set to **Automatic Mode**. Use the **Slope PWM 1** option to select the linear rate at which the PWM mode increases with respect to an increase in temperature. A list of available options is shown below:

- 0 PWM
- 1 PWM
- 2 PWM
- 4 PWM
- 8 PWM
- 16 PWM
- 32 PWM
- 64 PWM

The following system parameters and values are shown. The system parameters that are monitored are:

- **System Temperatures:** The following system temperatures are monitored

PPC-37xx-N270 Panel PC

- CPU Temperature
- System Temperature
- **Fan Speeds:** The CPU cooling fan speed is monitored.
 - CPU Fan Speed
- **Voltages:** The following system voltages are monitored
 - CPU Core
 - +1.05V
 - +3.30V
 - +12.0 V
 - +1.5V
 - +1.8V
 - 5VSB
 - VBAT

5.3.5 Power Configuration

The **Power Configuration** menu (BIOS Menu 8) configures the Advanced Configuration and Power Interface (ACPI) and Power Management (APM) options.

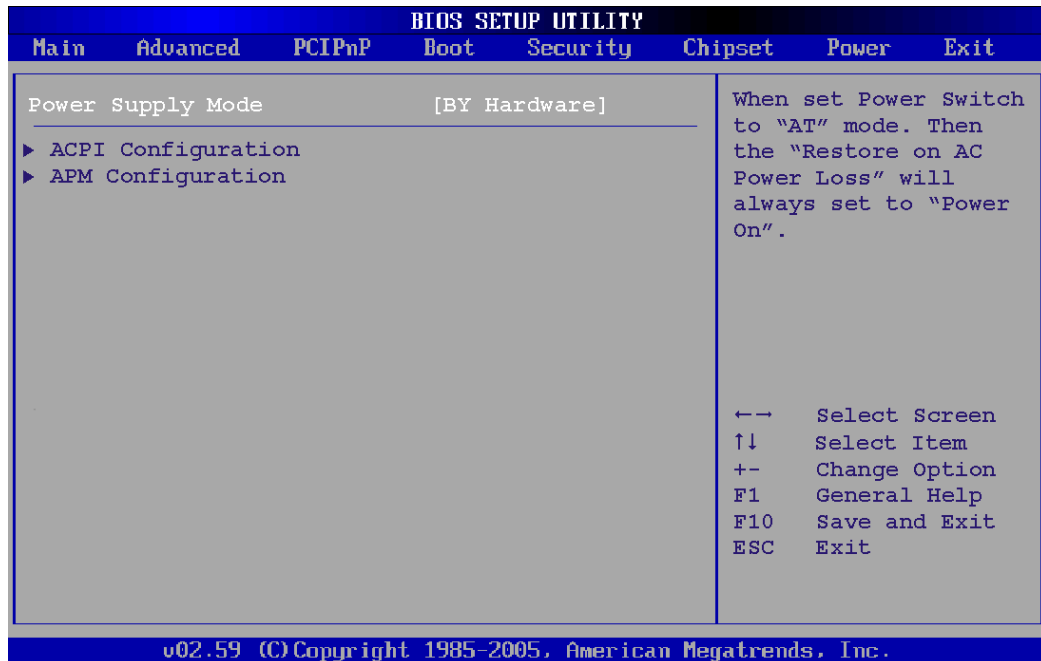

BIOS Menu 8: Power Configuration

5.3.5.1 ACPI configuration

The **ACPI Configuration** menu (**BIOS Menu 9**) configures the Advanced Configuration and Power Interface (ACPI).

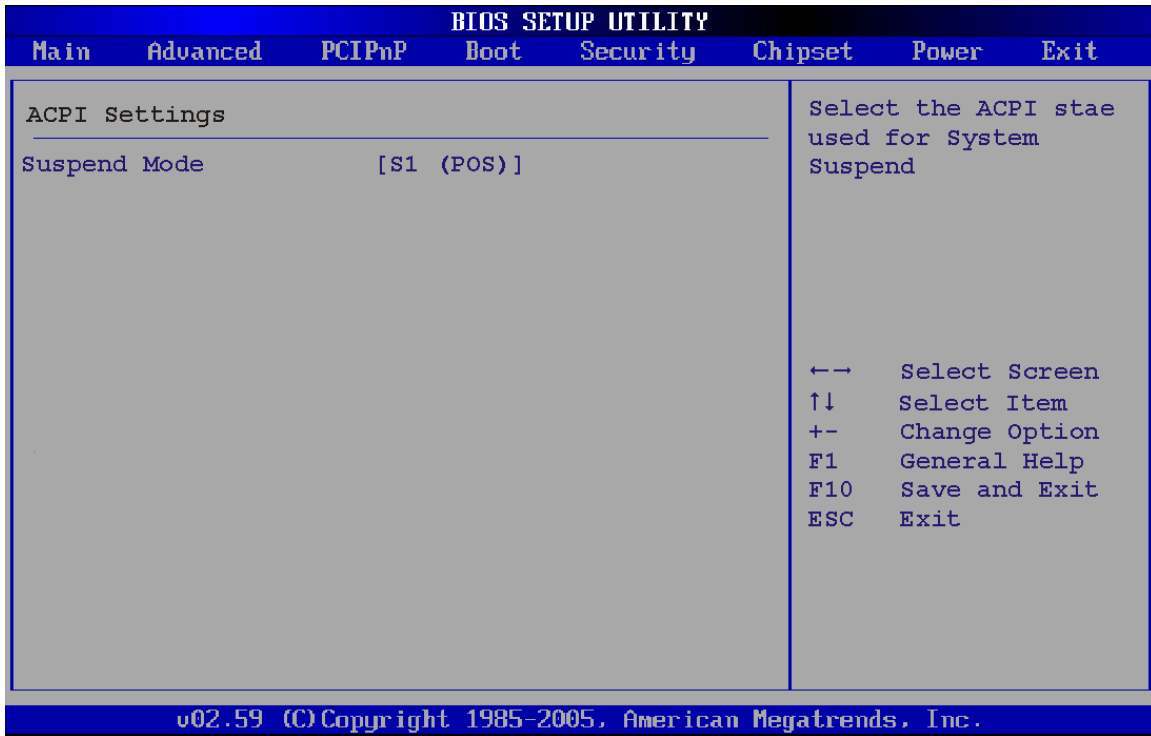

BIOS Menu 9: ACPI Configuration

→ Suspend Mode [S1(POS)]

Use the **Suspend Mode** BIOS option to specify the sleep state the system enters when it is not being used.

- **S1 (POS) DEFAULT** System appears off. The CPU is stopped; RAM is refreshed; the system is running in a low power mode.
- **S3 (STR)** System appears off. The CPU has no power; RAM is in slow refresh; the power supply is in a reduced power mode.

5.3.5.2 APM Configuration

The **APM Configuration** menu (**BIOS Menu 10**) allows the advanced power management options to be configured.

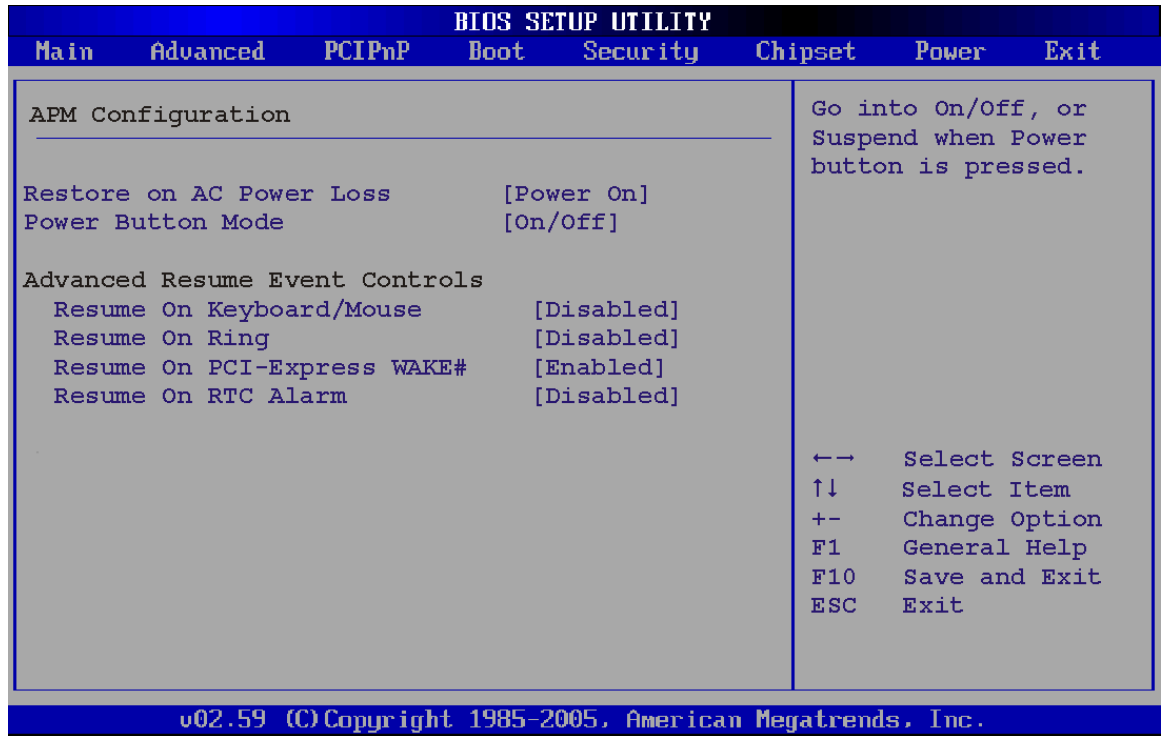

BIOS Menu 10: Advanced Power Management Configuration

→ Restore on AC Power Loss [Last State]

Use the **Restore on AC Power Loss** BIOS option to specify what state the system returns to if there is a sudden loss of power to the system.

- **Power Off** The system remains turned off
- **Power On** The system turns on
- **Last State** **DEFAULT** The system returns to its previous state. If it was on, it turns itself on. If it was off, it remains off.

→ Power Button Mode [On/Off]

Use the **Power Button Mode** BIOS to specify how the power button functions.

- **On/Off** **DEFAULT** When the power button is pressed the system is either turned on or off
- **Suspend** When the power button is pressed the system goes into suspend mode

→ **Resume on Keyboard/Mouse [Disabled]**

Use the **Resume on Keyboard/Mouse** BIOS option to enable activity on either the keyboard or mouse to rouse the system from a suspend or standby state. That is, the system is roused when the mouse is moved or a button on the keyboard is pressed.

- **Disabled** (Default) Wake event not generated by activity on the keyboard or mouse
- **Enabled** Wake event generated by activity on the keyboard or mouse

→ **Resume on Ring [Disabled]**

Use the **Resume on Ring** BIOS option to enable activity on the RI (ring in) modem line to rouse the system from a suspend or standby state. That is, the system will be roused by an incoming call on a modem.

- **Disabled** **DEFAULT** Wake event not generated by an incoming call
- **Enabled** Wake event generated by an incoming call

→ **Resume on PCI-Express WAKE# [Enabled]**

Use the **Resume PCI-Express WAKE#** BIOS option to enable activity on the PCI-Express WAKE# signal to rouse the system from a suspend or standby state.

- **Disabled** Wake event not generated by PCI-Express WAKE# signal activity
- **Enabled** **DEFAULT** Wake event generated by PCI-Express WAKE# signal

activity

→ **Resume On RTC Alarm [Disabled]**

Use the **Resume On RTC Alarm** option to specify the time the system should be roused from a suspended state.

→ **Disabled** **DEFAULT** The real time clock (RTC) cannot generate a wake event

→ **Enabled** If selected, the following appears with values that can be selected:

→ **RTC Alarm Date (Days)**

→ **System Time**

After setting the alarm, the computer turns itself on from a suspend state when the alarm goes off.

5.3.6 Remote Configuration

Use the **Remote Access Configuration** menu (**BIOS Menu 11**) to configure remote access parameters. The **Remote Access Configuration** is an AMIBIOS feature and allows a remote host running a terminal program to display and configure the BIOS settings.

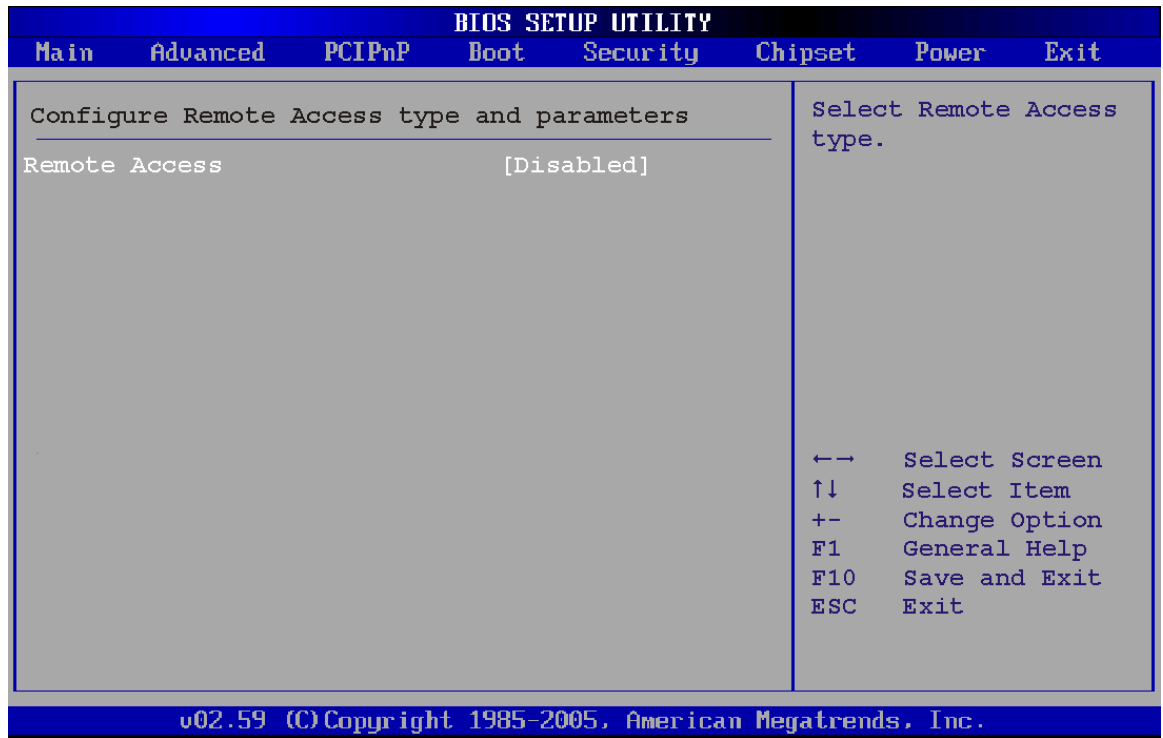

BIOS Menu 11: Remote Access Configuration [Advanced]

➔ **Remote Access [Disabled]**

Use the **Remote Access** option to enable or disable access to the remote functionalities of the system.

- ➔ **Disabled** **DEFAULT** Remote access is disabled.
- ➔ **Enabled** Remote access configuration options shown below appear:
 - ➔ **Serial Port Number**
 - ➔ **Serial Port Mode**
 - ➔ **Flow Control**
 - ➔ **Redirection after BIOS POST**
 - ➔ **Terminal Type**

→ VT-UTF8 Combo Key Support

These configuration options are discussed below.

→ Serial Port Number [COM1]

Use the **Serial Port Number** option allows to select the serial port used for remote access.

- COM1 DEFAULT** System is remotely accessed through COM1
- COM2** System is remotely accessed through COM2

NOTE: Make sure the selected COM port is enabled through the Super I/O configuration menu.

→ Base Address, IRQ [2F8h,3]

The **Base Address, IRQ** option cannot be configured and only shows the interrupt address of the serial port listed above.

→ Serial Port Mode [115200 8,n,1]

Use the **Serial Port Mode** option to select baud rate through which the console redirection is made. The following configuration options are available

- 115200 8,n,1 DEFAULT
- 57600 8,n,1
- 38400 8,n,1
- 19200 8,n,1
- 09600 8,n,1

**NOTE:**

Identical baud rate setting must be set on the host (a management computer running a terminal software) and the slave

→ Flow Control [None]

Use the **Flow Control** option to report the flow control method for the console redirection application.

- **None** **DEFAULT** No control flow,
- **Hardware** Hardware is set as the console redirection
- **Software** Software is set as the console redirection

→ Redirection After BIOS POST [Always]

Use the **Redirection After BIOS POST** option to specify when console redirection should occur.

- **Disabled** The console is not redirected after POST
- **Boot Loader** Redirection is active during POST and during Boot Loader
- **Always** **DEFAULT** Redirection is always active (Some OSES may not work if set to Always)

→ Terminal Type [ANSI]

Use the **Terminal Type** BIOS option to specify the remote terminal type.

- **ANSI** **DEFAULT** The target terminal type is ANSI
- **VT100** The target terminal type is VT100
- **VT-UTF8** The target terminal type is VT-UTF8

→ VT-UTF8 Combo Key Support [Disabled]

Use the **VT-UFT8 Combo Key Support** option to enable additional keys that are not provided by VT100 for the PC 101 keyboard.

The VT100 Terminal Definition is the standard convention used to configure and conduct emergency management tasks with UNIX-based servers. VT100 does not support all keys

PPC-37xx-N270 Panel PC

on the standard PC 101-key layout, however. The VT-UTF8 convention makes available additional keys that are not provided by VT100 for the PC 101 keyboard.

- **Disabled** **DEFAULT** Disables the VT-UTF8 terminal keys
- **Enabled** Enables the VT-UTF8 combination key. Support for ANSI/VT100 terminals

→ **Sredir Memory Display Delay [Disabled]**

Use the **Sredir Memory Display Delay** option to select the delay before memory information is displayed. Configuration options are listed below

- No Delay **DEFAULT**
- Delay 1 sec
- Delay 2 sec
- Delay 4 sec

5.3.7 USB Configuration

Use the **USB Configuration** menu (**BIOS Menu 12**) to read USB configuration information and configure the USB settings.

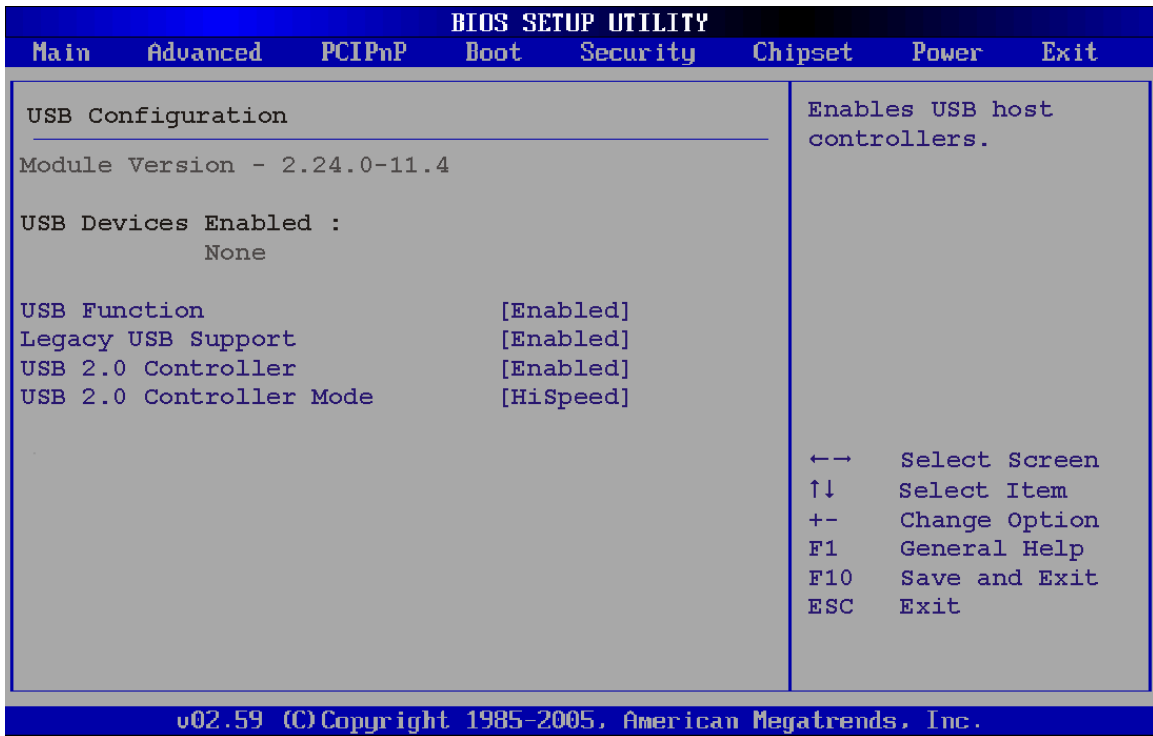

BIOS Menu 12: USB Configuration

→ USB Functions [Enabled]

Use the **USB Function** option to enable or disable the USB controllers.

- Disabled USB controllers are enabled
- Enabled **DEFAULT** USB controllers are disabled

→ USB 2.0 Controller [Enabled]

The **USB 2.0 Controller** BIOS option enables or disables the USB 2.0 controller

- Disabled USB function disabled
- Enabled **DEFAULT** USB function enabled

→ USB2.0 Controller Mode [HiSpeed]

The **USB2.0 Controller Mode** BIOS option sets the speed of the USB2.0 controller.

PPC-37xx-N270 Panel PC

- **FullSpeed** The controller is capable of operating at full speed
12 Mb/s
- **HiSpeed** **DEFAULT** The controller is capable of operating at high speed
480 Mb/s

→ **Legacy USB Support [Enabled]**

Use the **Legacy USB Support** BIOS option to enable USB mouse and USB keyboard support.

Normally if this option is not enabled, any attached USB mouse or USB keyboard does not become available until a USB compatible operating system is fully booted with all USB drivers loaded. When this option is enabled, any attached USB mouse or USB keyboard can control the system even when there is no USB driver loaded onto the system.

- **Disabled** Legacy USB support disabled
- **Enabled** **DEFAULT** Legacy USB support enabled
- **Auto** Legacy USB support disabled if no USB devices are
connected

5.4 PCI/PnP

Use the PCI/PnP menu (BIOS Menu 13) to configure advanced PCI and PnP settings.



WARNING:

Setting wrong values for the BIOS selections in the PCIPnP BIOS menu may cause the system to malfunction.

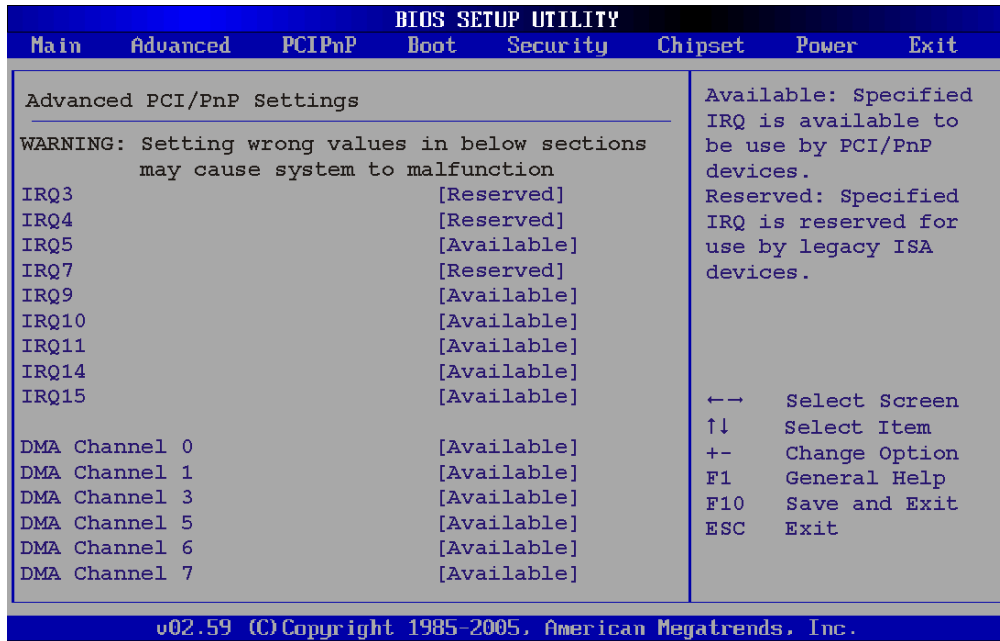

BIOS Menu 13: PCI/PnP Configuration

→ **IRQ# [Available]**

Use the **IRQ#** address to specify what IRQs can be assigned to a particular peripheral device.

→ **Available** **DEFAULT** The specified IRQ is available to be used by PCI/PnP devices

→ **Reserved** The specified IRQ is reserved for use by Legacy ISA devices

Available IRQ addresses are:

- IRQ3
- IRQ4
- IRQ5
- IRQ7
- IRQ9
- IRQ10
- IRQ 11

PPC-37xx-N270 Panel PC

- IRQ 14
- IRQ 15

→ **DMA Channel# [Available]**

Use the **DMA Channel#** option to assign a specific DMA channel to a particular PCI/PnP device.

- | | | | |
|---|------------------|----------------|--|
| → | Available | DEFAULT | The specified DMA is available to be used by PCI/PnP devices |
| → | Reserved | | The specified DMA is reserved for use by Legacy ISA devices |

Available DMA Channels are:

- DM Channel 0
- DM Channel 1
- DM Channel 3
- DM Channel 5
- DM Channel 6
- DM Channel 7

→ **Reserved Memory Size [Disabled]**

Use the **Reserved Memory Size** BIOS option to specify the amount of memory that should be reserved for legacy ISA devices.

- | | | | |
|---|-----------------|----------------|---|
| → | Disabled | DEFAULT | No memory block reserved for legacy ISA devices |
| → | 16K | | 16KB reserved for legacy ISA devices |
| → | 32K | | 32KB reserved for legacy ISA devices |
| → | 64K | | 54KB reserved for legacy ISA devices |

5.5 Boot

Use the Boot menu (BIOS Menu 14) to configure system boot options.

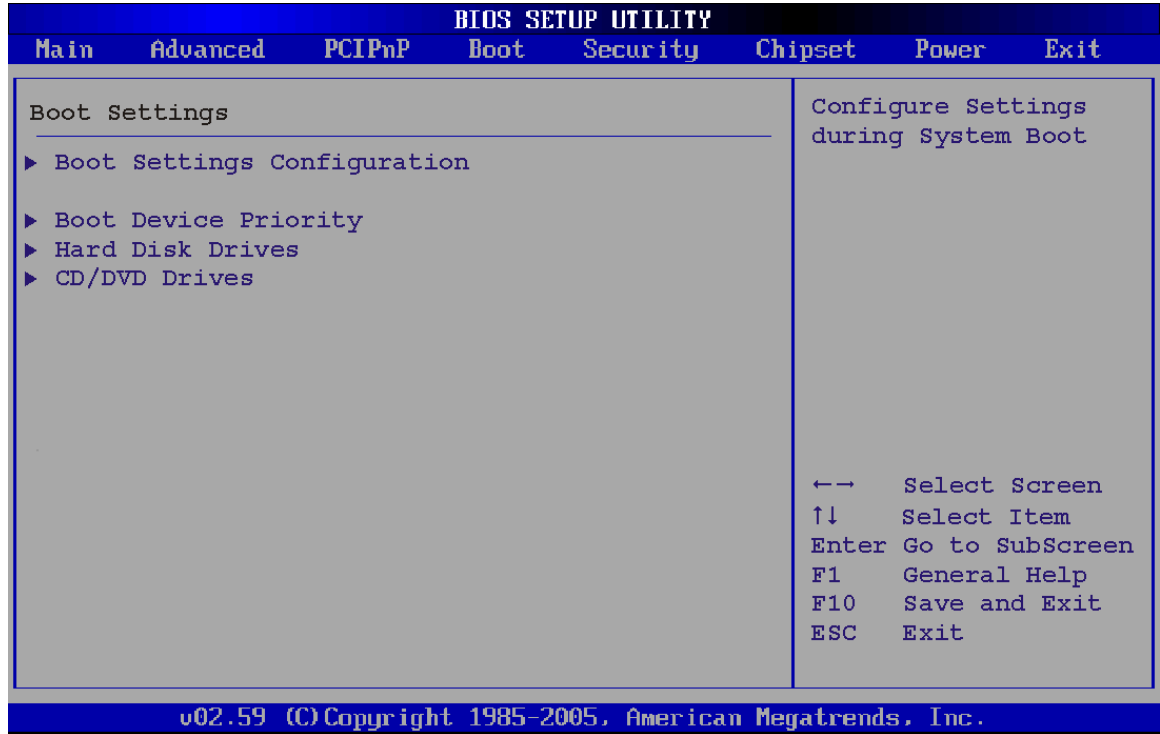

BIOS Menu 14: Boot

5.5.1 Boot Settings Configuration

Use the Boot Settings Configuration menu (BIOS Menu 14) to configure advanced system boot options.

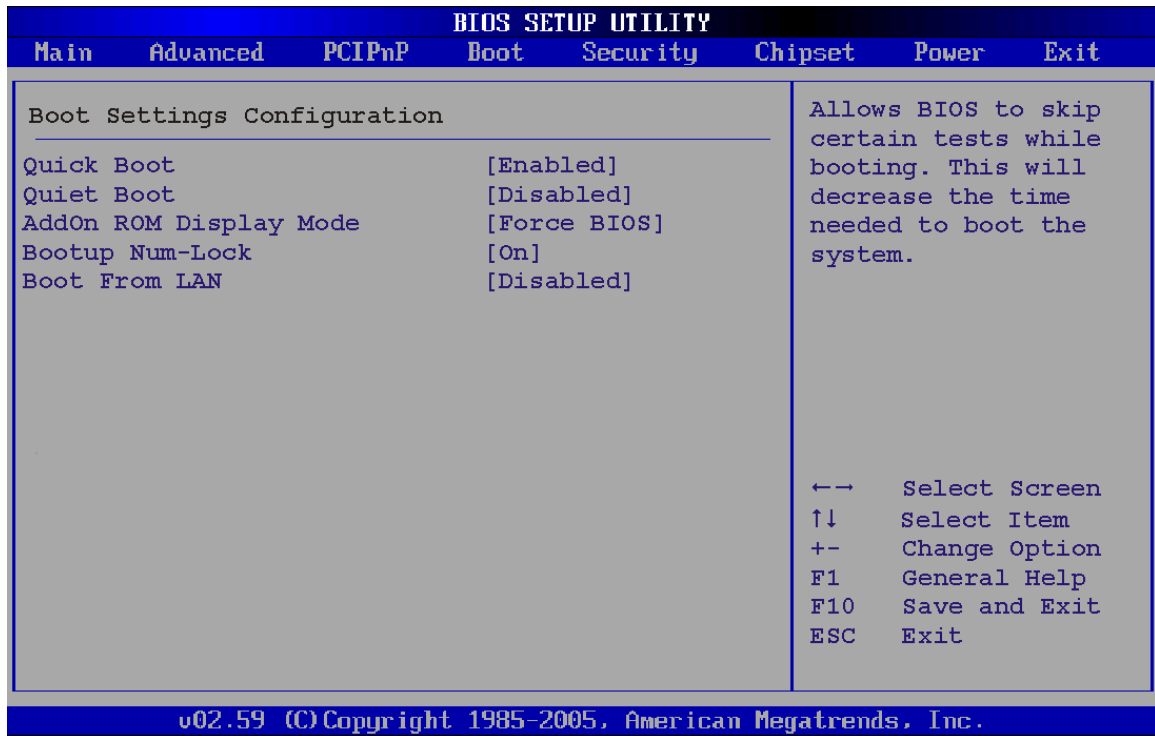

BIOS Menu 15: Boot Settings Configuration

→ Quick Boot [Enabled]

Use the **Quick Boot** BIOS option to make the computer speed up the boot process.

- **Disabled** No POST procedures are skipped
- **Enabled** **DEFAULT** Some POST procedures are skipped to decrease the system boot time

→ Quiet Boot [Disabled]

Use the **Quiet Boot** BIOS option to select the screen display when the system boots.

- **Disabled** **DEFAULT** Normal POST messages displayed
- **Enabled** OEM Logo displayed instead of POST messages

→ AddOn ROM Display Mode [Force BIOS]

The **AddOn ROM Display Mode** option allows add-on ROM (read-only memory) messages to be displayed.

- Force BIOS DEFAULT** Allows the computer system to force a third party BIOS to display during system boot.
- Keep Current** Allows the computer system to display the information during system boot.

→ Bootup Num-Lock [Off]

The **Bootup Num-Lock** BIOS option allows the Number Lock setting to be modified during boot up.

- Off DEFAULT** Does not enable the keyboard Number Lock automatically. To use the 10-keys on the keyboard, press the Number Lock key located on the upper left-hand corner of the 10-key pad. The Number Lock LED on the keyboard lights up when the Number Lock is engaged.
- On** Allows the Number Lock on the keyboard to be enabled automatically when the computer system boots up. This allows the immediate use of the 10-key numeric keypad located on the right side of the keyboard. To confirm this, the Number Lock LED light on the keyboard is lit.

→ Boot From LAN Support [Disabled]

The **BOOT From LAN Support** option enables the system to be booted from a remote system.

- Disabled DEFAULT** Cannot be booted from a remote system through the LAN
- Enabled DEFAULT** Can be booted from a remote system through the LAN

PPC-37xx-N270 Panel PC

5.5.2 Boot Device Priority

Use the **Boot Device Priority** menu (**BIOS Menu 16**) to specify the boot sequence from the available devices. The following options are available:

- 1st Boot Device
- 2nd Boot Device
- 3rd Boot Device

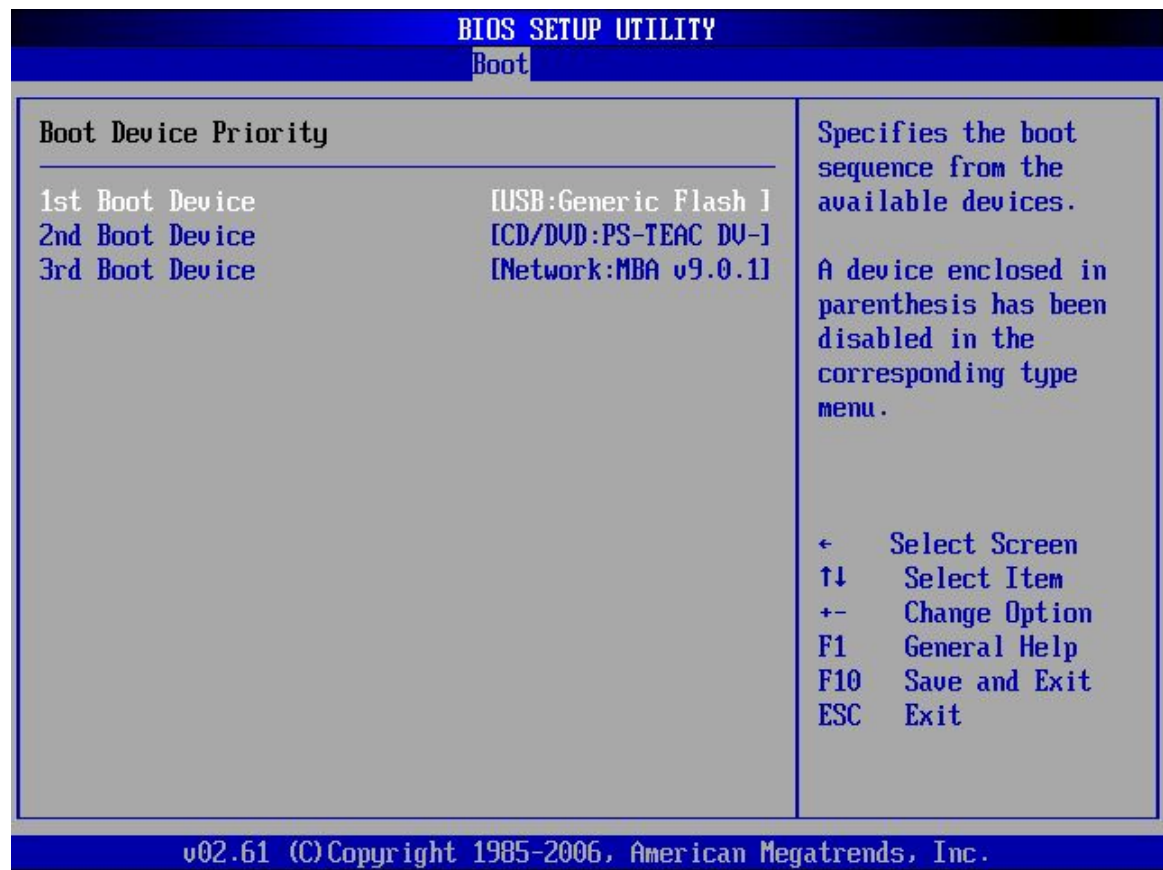

BIOS Menu 16: Boot Device Priority Settings

5.6 Security

Use the Security menu (**BIOS Menu 17**) to set system and user passwords.

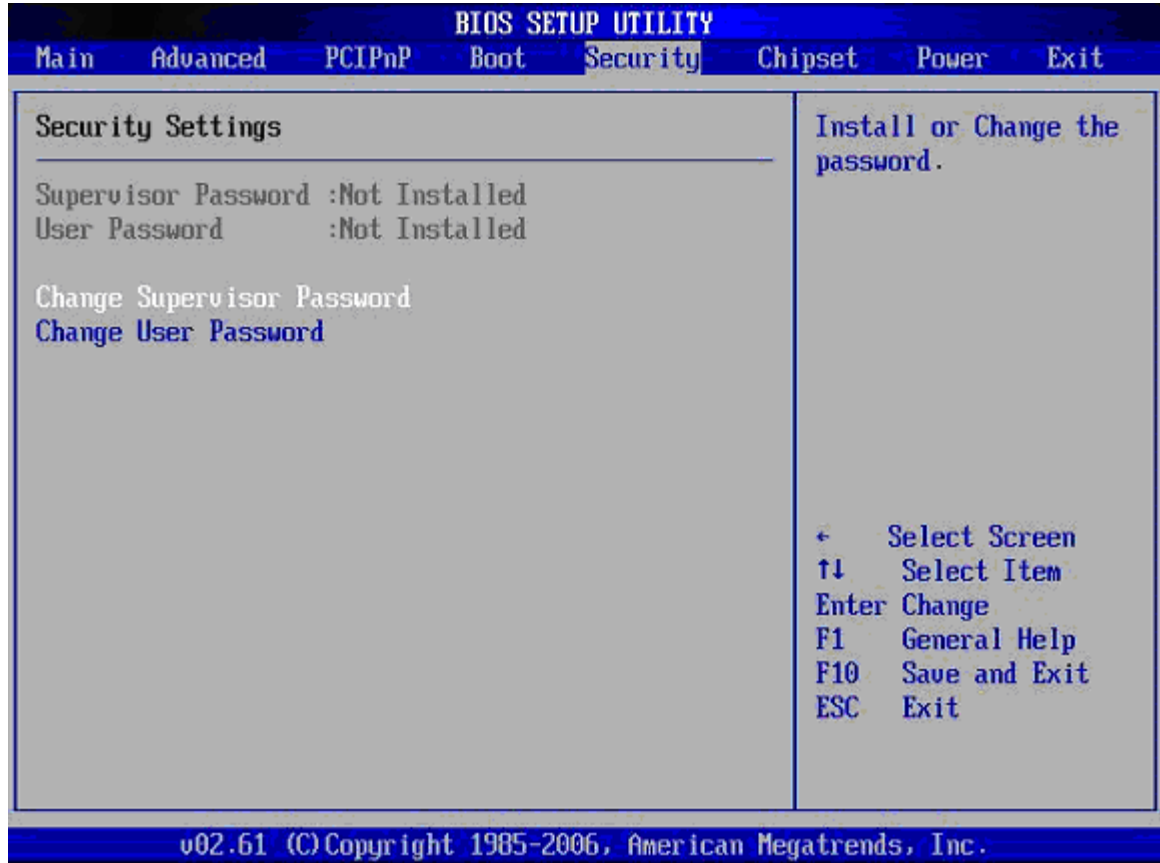

BIOS Menu 17: Security

→ Change Supervisor Password

Use the **Change Supervisor Password** to set or change a supervisor password. The default for this option is **Not Installed**. If a supervisor password must be installed, select this field and enter the password. After the password has been added, **Install** appears next to **Change Supervisor Password**.

→ Change User Password

Use the **Change User Password** to set or change a user password. The default for this option is **Not Installed**. If a user password must be installed, select this field and enter the

PPC-37xx-N270 Panel PC

password. After the password has been added, **Install** appears next to **Change User Password**.

5.7 Chipset

Use the **Chipset** menu (**BIOS Menu 18**) to access the NorthBridge and SouthBridge configuration menus



WARNING!

Setting the wrong values for the Chipset BIOS selections in the Chipset BIOS menu may cause the system to malfunction.

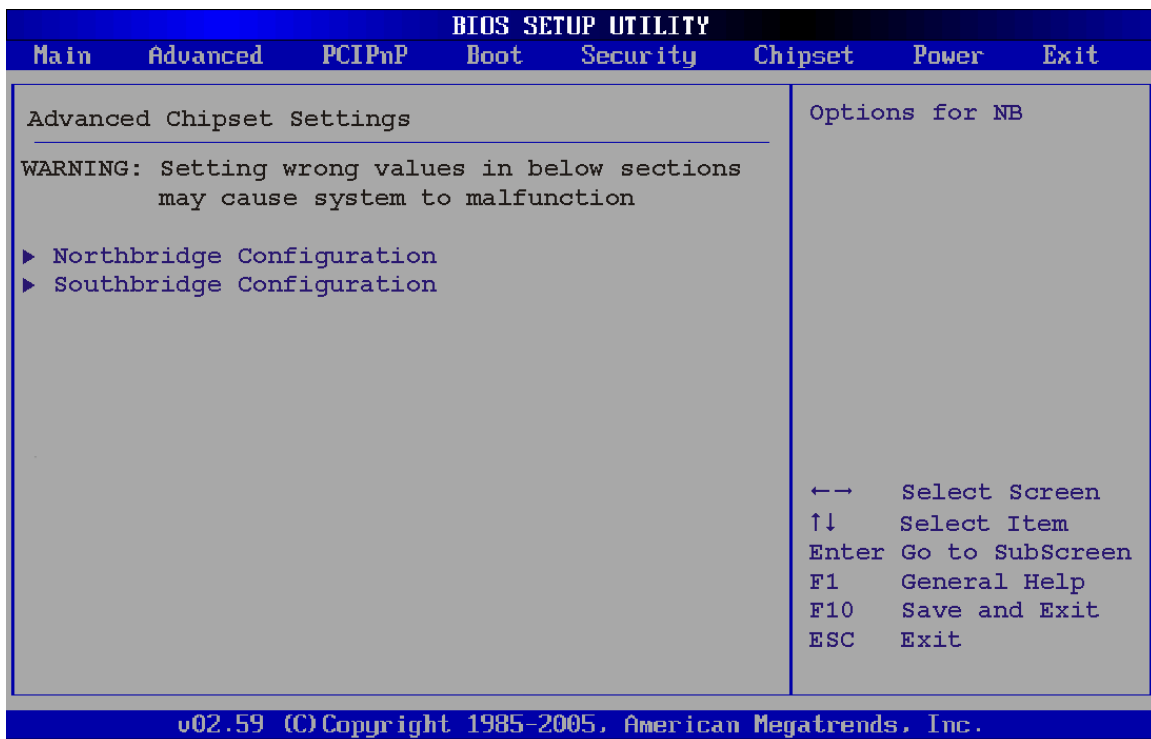

BIOS Menu 18: Chipset

5.7.1 North Bridge Chipset Configuration

Use the **North Bridge Chipset Configuration** menu (**BIOS Menu 18**) to configure the Northbridge chipset settings.

BIOS SETUP UTILITY							
Main	Advanced	PCIPnP	Boot	Security	Chipset	Power	Exit
Northbridge						Options	
Memory Hole						[Disabled]	
Internal Graphics Mode Select						[Enabled, 8MB]	
Video Function Configuration							
DVMT Mode Select						[DVMT Mode]	
DVMT/FIXED Memory						[128MB]	
Boot Display Device						[Auto]	
LVDS1 Panel Type						[by H/W]	
LVDS1 Current Jumper Setting						[800x600 18b]	
LVDS2 Panel Type						[by H/W]	
LVDS2 Current Jumper Setting						[800x600 18b]	
LCD Brightness Control						[100]	
TV Standard						[VBIOS-Default]	
						←→ Select Screen	
						↑↓ Select Item	
						+- Change Option	
						F1 General Help	
						F10 Save and Exit	
						ESC Exit	
v02.59 (C) Copyright 1985-2005, American Megatrends, Inc.							

BIOS Menu 19:North Bridge Chipset Configuration

➔ Memory Hole [Disabled]

The **Memory Hole** reserves the memory space between 15MB and 16MB for ISA expansion cards that require a specified area of memory to work properly. If an older ISA expansion card is used, please refer to the documentation that came with the card to see if it is necessary to reserve the space.

- ➔ **Disabled** **DEFAULT** Memory is not reserved for ISA expansion cards
- ➔ **Enabled** Memory is reserved for ISA expansion cards

PPC-37xx-N270 Panel PC

→ Internal Graphics Mode Select [Enable, 8MB]

The **Internal Graphic Mode Select** option determines the amount of system memory that can be used by the Internal graphics device.

- **Disable**
- **Enable, 1MB** 1MB of memory used by internal graphics device
- **Enable, 8MB** **DEFAULT** 8MB of memory used by internal graphics device

→ DVMT Mode Select [DVMT Mode]

Use the **DVMT Mode Select** option to select the Intel Dynamic Video Memory Technology (DVMT) operating mode.

- **Fixed Mode** A fixed portion of graphics memory is reserved as graphics memory.
- **DVMT Mode** **DEFAULT** Graphics memory is dynamically allocated according to the system and graphics needs.
- **Combo Mode** A fixed portion of graphics memory is reserved as graphics memory. If more memory is needed, graphics memory is dynamically allocated according to the system and graphics needs.

→ DVMT/FIXED Memory

Use the **DVMT/FIXED Memory** option to specify the maximum amount of memory that can be allocated as graphics memory. This option can only be configured for if **DVMT Mode** or **Fixed Mode** is selected in the **DVMT Mode Select** option. If **Combo Mode** is selected, the maximum amount of graphics memory is 128MB. Configuration options are listed below.

- 64MB
- 128MB **DEFAULT**
- Maximum DVMT

→ Boot Display Device [CRT]

The **Boot Display Device** BIOS option selects the display device the system uses when it boots. The available options are listed below:

- Auto **DEFAULT**
- CRT
- TV
- LFP
- LFP1

→ LVDS Panel Type

Use the **LVDS Panel Type** to determine the LCD panel resolution. Configuration options are listed below:

- 640 x 480 18b
- 800 x 480 18b
- 800 x 600 18b
- 1024 x 768 18b
- 1280 x 1024 36b
- 1400 x 1050 36b
- 1440 x 900 36b
- 1600 x 1200 36b
- by H/W

→ LCD Brightness Control

Use the **LCD Brightness Control** option to specify the brightness of the LCD panel as a percentage. Default setting is 100%

→ TV Standard

The **TV Standard** option specifies the TV type connected to the system.

- VBIOS-Default DEFAULT TV type is set to VBIOS-Default**
- NTSC TV type is set to NTSC**

PPC-37xx-N270 Panel PC

→	PAL	TV type is set to PAL
→	SECAM	TV type is set to SECAM
→	SMPTE240M	TV type is set to SMPTE240M
→	ITU-R television	TV type is set to ITU-R television
→	SMPTE260M	TV type is set to SMPTE260M
→	SMPTE295M	TV type is set to SMPTE295M
→	SMPTE296M	TV type is set to SMPTE296M
→	EIA-770.2	TV type is set to EIA-770.2
→	EIA-770.3	TV type is set to EIA-770.3

5.7.2 SouthBridge Configuration

The **SouthBridge Configuration** menu (BIOS Menu 20) the southbridge chipset to be configured.

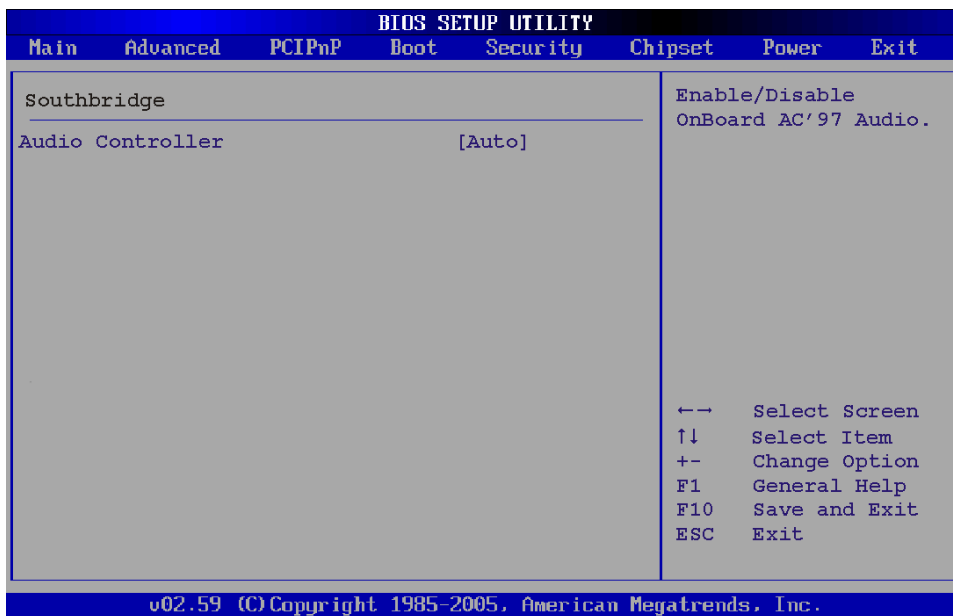

BIOS Menu 20:SouthBridge Chipset Configuration

→ Audio Controller [All Disabled]

The **Audio Controller** option enables or disables the audio controller.

- Azalia Audio controller configured as Azalia
- AC'97 Audio Only The on-board AC'97 audio controller is enabled.
- All Disabled **DEFAULT** The on-board audio controller is disabled.

5.8 Exit

Use the **Exit** menu (**BIOS Menu 21**) to load default BIOS values, optimal failsafe values and to save configuration changes.



BIOS Menu 21:Exit

- **Save Changes and Exit**

Use the **Save Changes and Exit** option to save the changes made to the BIOS options and to exit the BIOS configuration setup program.

PPC-37xx-N270 Panel PC

→ Discard Changes and Exit

Use the **Discard Changes and Exit** option to exit the BIOS configuration setup program without saving the changes made to the system.

→ Discard Changes

Use the **Discard Changes** option to discard the changes and remain in the BIOS configuration setup program.

→ Load Optimal Defaults

Use the **Load Optimal Defaults** option to load the optimal default values for each of the parameters on the Setup menus. **F9 key can be used for this operation.**

→ Load Failsafe Defaults

Use the **Load Failsafe Defaults** option to load failsafe default values for each of the parameters on the Setup menus. **F8 key can be used for this operation.**

Chapter

6

Driver Installation

6.1 Available Software Drivers

**NOTE:**

The content of the CD may vary throughout the life cycle of the product and is subject to change without prior notice. You may visit the IEI website or contact technical support for the latest updates.

The following drivers can be installed on the system.

- Chipset driver
- VGA driver
- LAN driver
- Audio driver
- Touchscreen driver

Installation instructions are given below.

6.2 Driver CD Auto-run

All the drivers for the PPC-37xx-N270 are on the CD that came with the system. To install the drivers, please follow the steps below.

Step 1: Insert the CD into a CD drive connected to the system.

Step 2: The driver CD starts up automatically

Step 3: A new screen with a list of available drivers appears (**Figure 6-1**).



Figure 6-1: Available Drivers

Step 4: Select the PPC-37xx-N270 driver to install from the list in **Figure 6-1**.

6.3 Chipset Driver Installation

To install the chipset driver, please follow the steps below:

Step 1: Select "1.CHIPSET" from the list in **Figure 6-1**.

Step 2: A new window opens (**Figure 6-2**).

PPC-37xx-N270 Panel PC

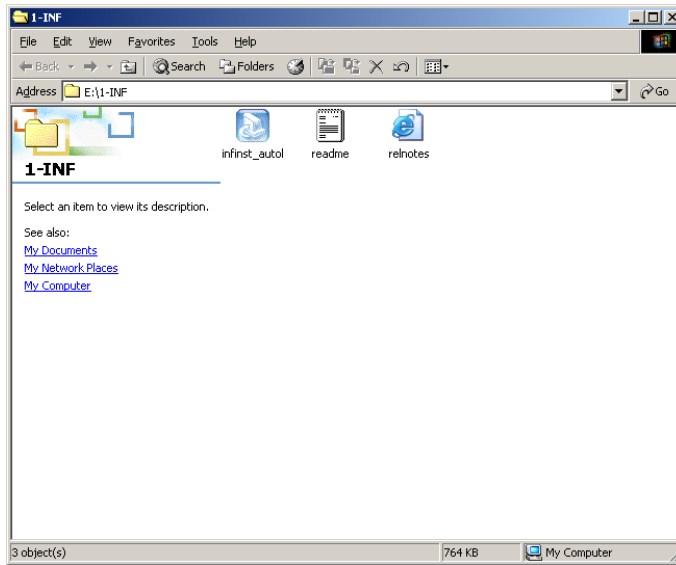

Figure 6-2: Chipset Driver Installation Program

Step 3: Double click the **infinst_Autol** icon in **Figure 6-2**.

Step 4: When the setup files are completely extracted the **Welcome Screen** in **Figure 6-3** appears.



Figure 6-3: Chipset Driver Welcome Screen

Step 5: Click **Next** to continue.

Step 6: The license agreement in **Figure 6-4** appears.



Figure 6-4: Chipset Driver License Agreement

Step 7: Read the **License Agreement**.

Step 8: Click the **YES** button to accept the license agreement and continue.

Step 9: The Read Me file in **Figure 6-5** appears.

PPC-37xx-N270 Panel PC



Figure 6-5: Chipset Driver Read Me File

Step 10: Click **NEXT** to continue.

Step 11: **Setup Operations** are performed as shown in **Figure 6-6**.



Figure 6-6: Chipset Driver Setup Operations

Step 12: Once the **Setup Operations** are complete, click the **NEXT** icon to continue.

Step 13: The **Finish** screen appears.



Figure 6-7: Chipset Driver Installation Finish Screen

Step 14: Select “**Yes, I want to restart the computer now**” and click the **Finish** icon.

See **Figure 6-7**.

6.4 Intel® Graphics Media Accelerator Driver

To install the chipset driver, please follow the steps below:

Step 1: Select “**2.VGA**” from the list in **Figure 6-1**.

Step 2: A new window opens (**Figure 6-8**).

PPC-37xx-N270 Panel PC

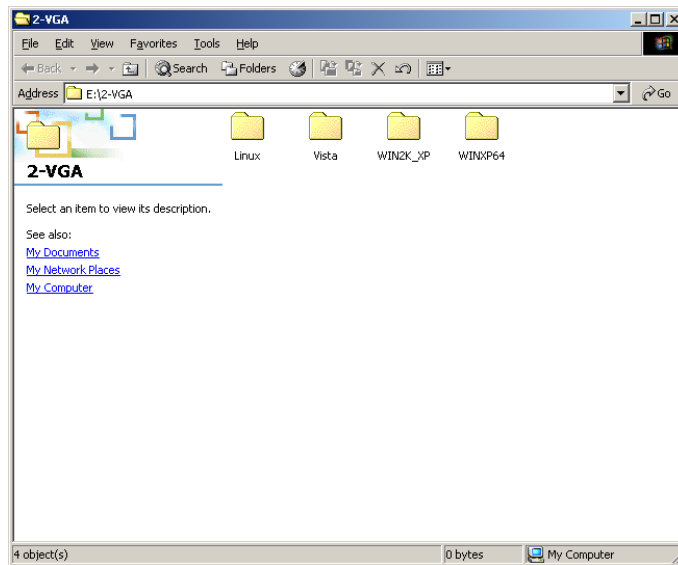

Figure 6-8: Select the Operating System

Step 3: Select the operating system from those shown in **Figure 6-8**.

Step 4: A new window appears (**Figure 6-9**).

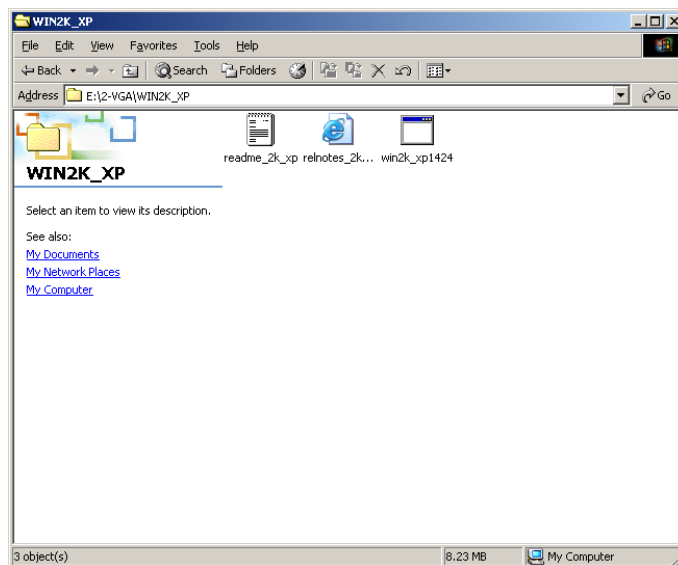

Figure 6-9: VGA Driver

Step 5: Click the installation program icon in **Figure 6-9**.

Step 6: The Readme information file shown in **Figure 6-10** appears.

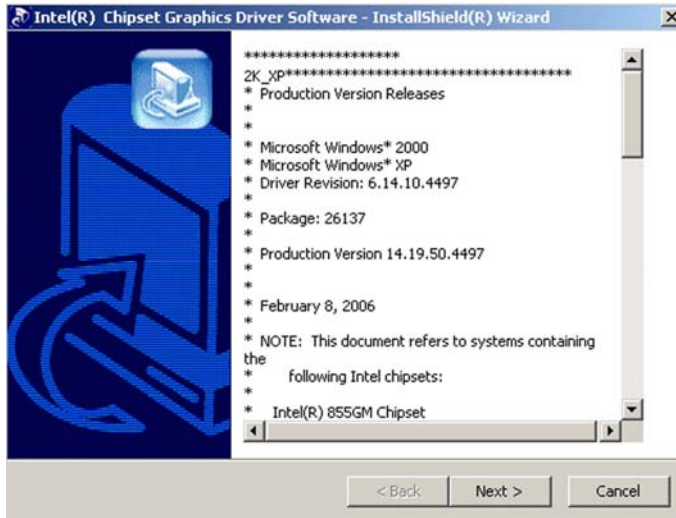

Figure 6-10: GMA Driver Readme File

Step 7: Click **NEXT** to extract the GMA driver files. See Figure 6-11.

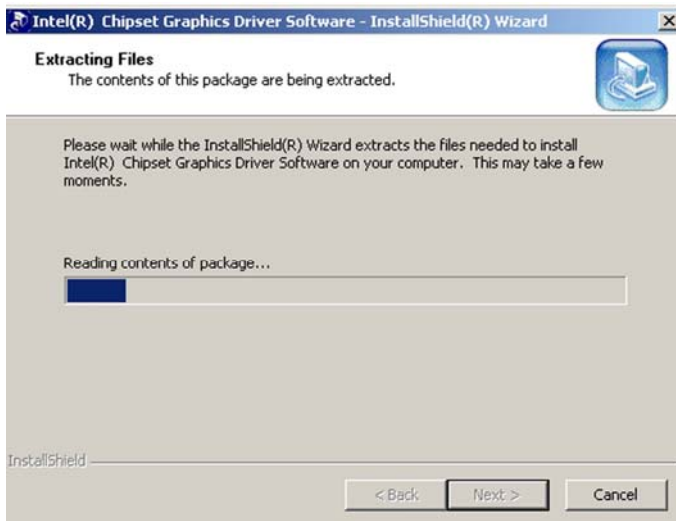

Figure 6-11: GMA Driver File Extraction

Step 8: The **Welcome Screen** in Figure 6-12 appears.

PPC-37xx-N270 Panel PC



Figure 6-12: VGA Driver Welcome Screen

Step 9: Click **NEXT** to continue.

Step 10: The license agreement in **Figure 6-13** appears.

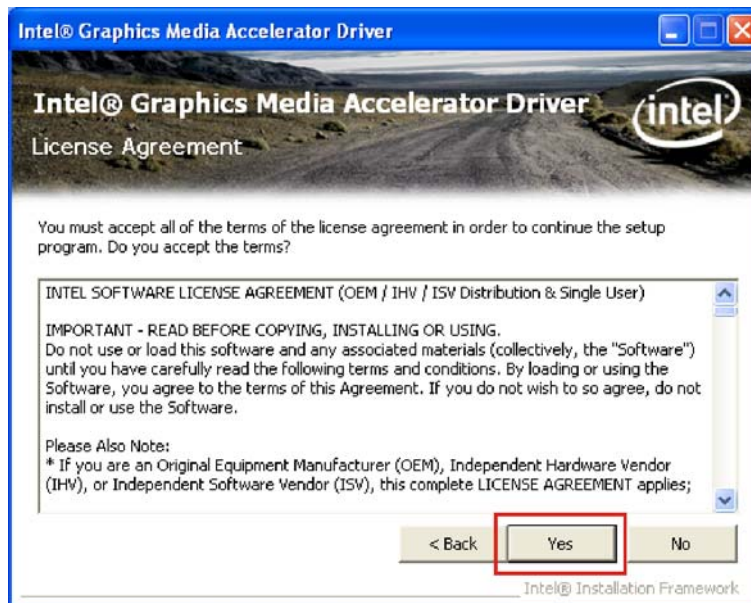

Figure 6-13: VGA Driver License Agreement

Step 11: Read the License Agreement.

Step 12: Click **YES** to accept the license agreement and continue.

Step 13: The Readme file in **Figure 6-14** appears.

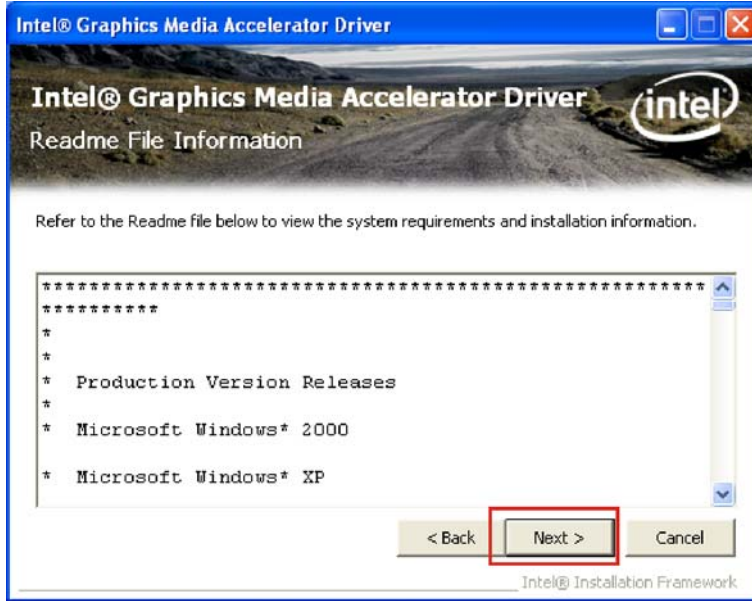

Figure 6-14: VGA Driver Read Me File

Step 14: Click **NEXT** to continue.

Step 15: Setup Operations are performed as shown in **Figure 6-15**.



NOTE:

The “Found New Hardware Wizard” will appear and then disappear during this step. Do not adjust any settings in the “Found New Hardware Wizard” window.

PPC-37xx-N270 Panel PC

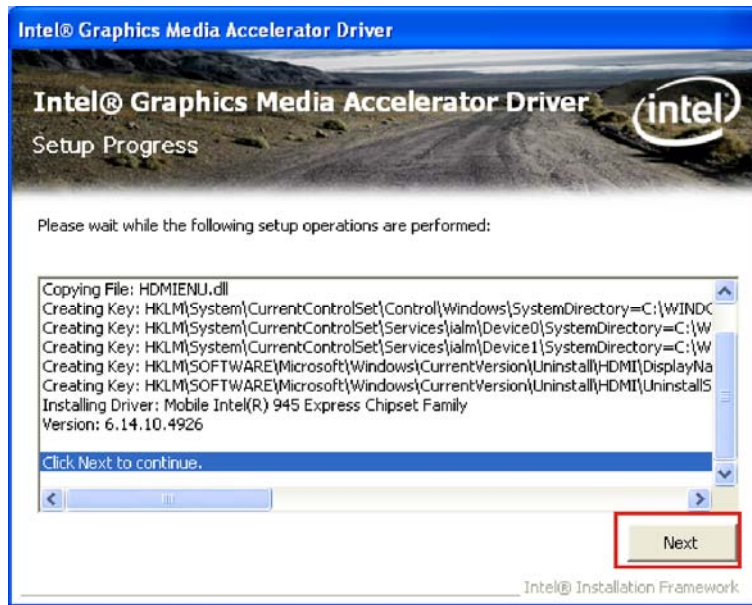

Figure 6-15: VGA Driver Setup Operations

Step 16: Once the **Setup Operations** are complete, click **NEXT** to continue.

Step 17: The **Finish** screen appears.

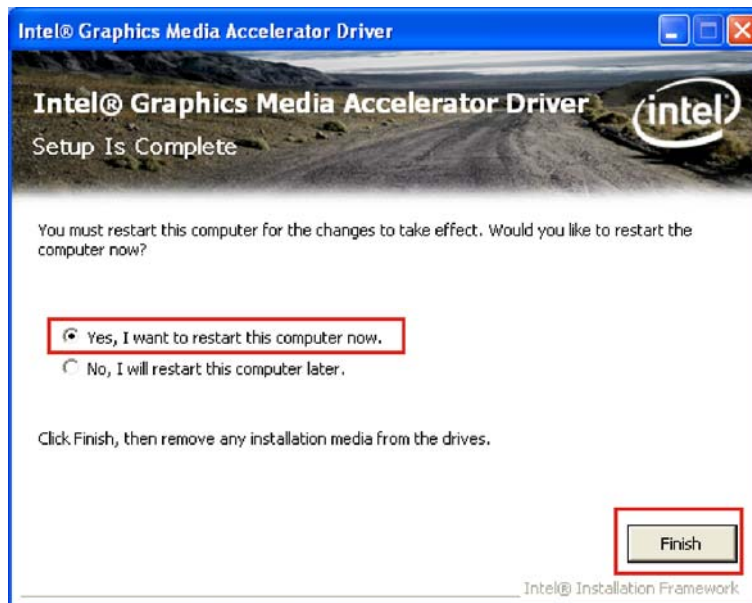

Figure 6-16: VGA Driver Installation Finish Screen

Step 18: Select “Yes, I want to restart the computer now” and click **FINISH**. See

Figure 6-16.

6.5 Realtek LAN Driver Installation

To install the chipset driver, please do the following.

Step 1: Select “3.LAN” from the list in **Figure 6-1**.

Step 2: The **Welcome** screen in **Figure 6-17** appears.

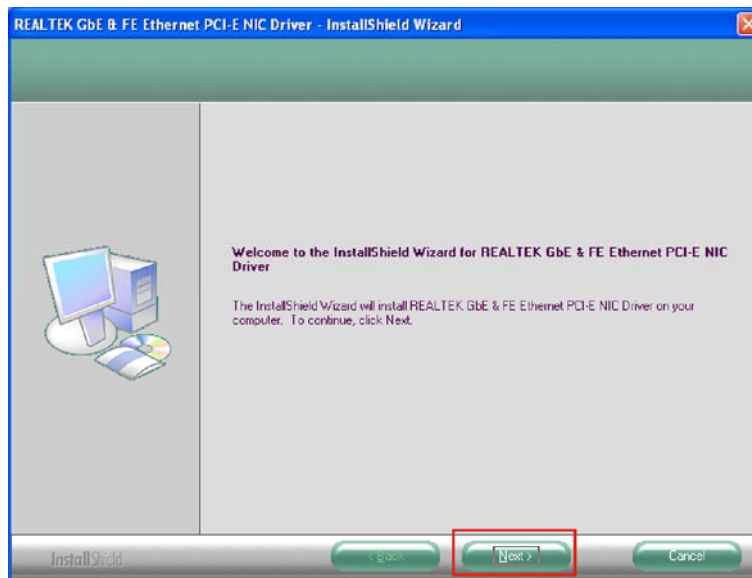

Figure 6-17: LAN Driver Welcome Screen

Step 3: Click **NEXT** to continue.

Step 4: The **Ready to Install** screen in **Figure 6-18** appears.

PPC-37xx-N270 Panel PC

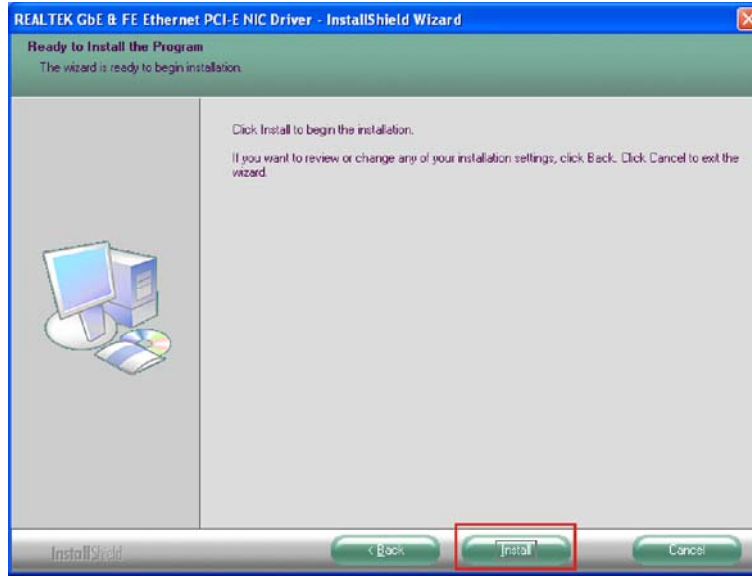

Figure 6-18: LAN Driver Welcome Screen

Step 5: Click **NEXT** to proceed with the installation.

Step 6: The program begins to install.

Step 7: The installation progress can be monitored in the progress bar shown in

Figure 6-19.

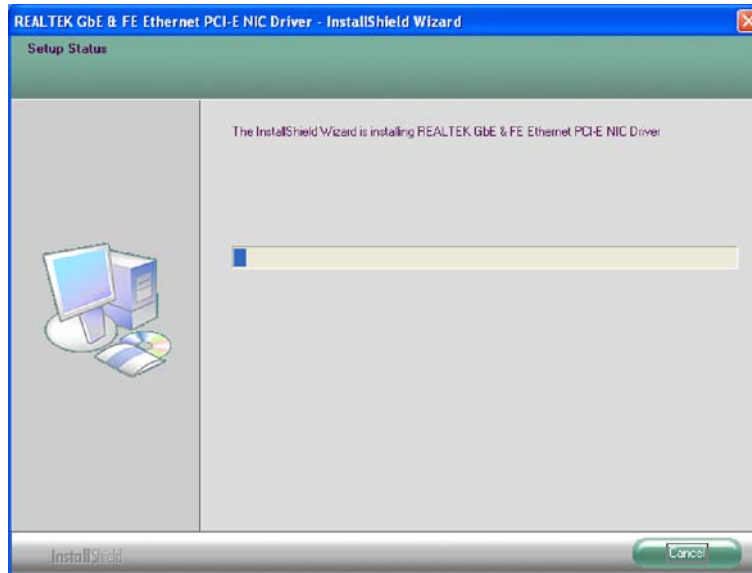

Figure 6-19: LAN Driver Installation

Step 8: When the driver installation is complete, the screen in **Figure 6-20** appears.

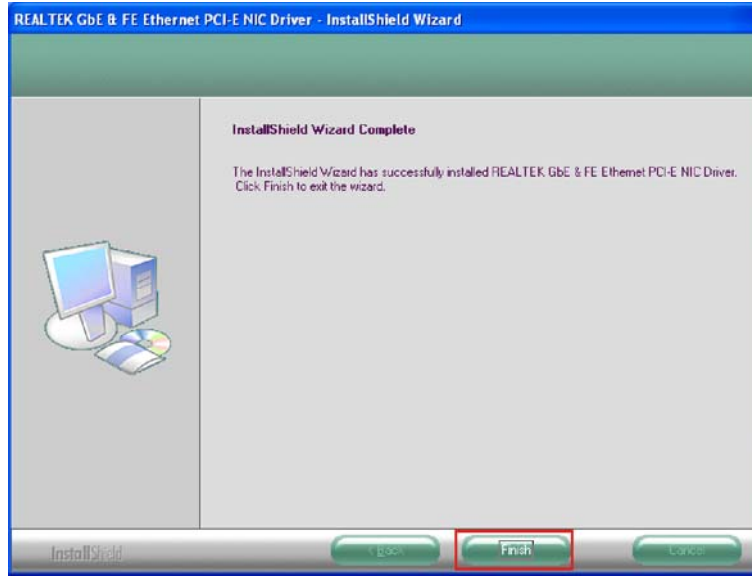

Figure 6-20: LAN Driver Installation Complete

Step 9: Click **FINISH** to exit the InstallShield Wizard (Figure 6-20).

6.6 Realtek AC`97 Audio Driver (ALC655) Installation

To install the Realtek AC `97 audio driver, please follow the steps below.

6.6.1 BIOS Setup

Step 1: Enter the BIOS setup. To do this, reboot the system and press **DEL** during POST.

Step 2: Go to the Southbridge Configuration menu. Set the **Audio Controller** option to [AC`97]. See **Section 5.7.2** for details.

Step 3: Press **F10** to save the changes and exit the BIOS setup. The system reboots.

6.6.2 Driver Installation

Step 1: Select "**4.AUDIO**" from the list in **Figure 6-1**

Step 2: A new window opens (**Figure 6-21**).

PPC-37xx-N270 Panel PC

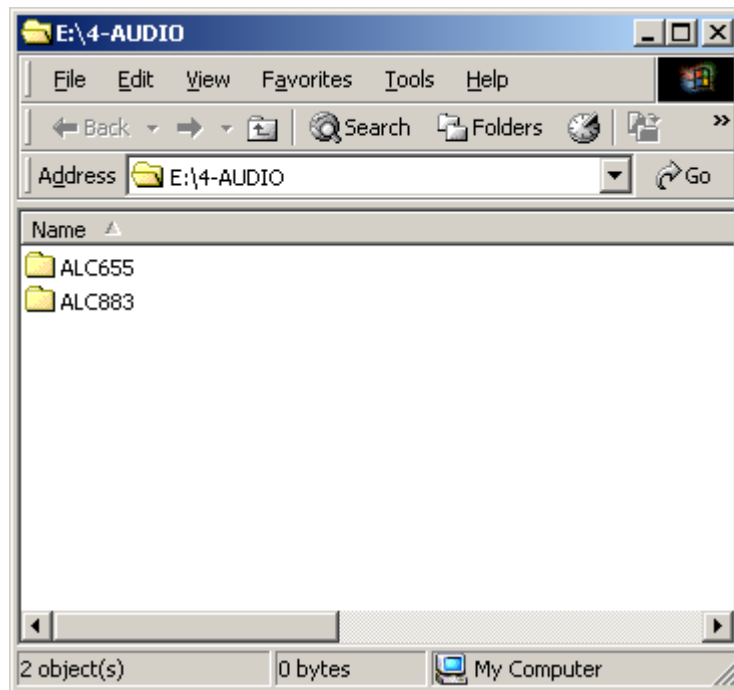

Figure 6-21: Select the Audio CODEC

Step 3: Double-click the ALC665 folder. Locate and double-click the **WDM_A384.exe** file to begin the driver installation process.

Step 4: Once you double click the **Setup** icon, the install shield wizard for the audio driver starts. See **Figure 6-22**.

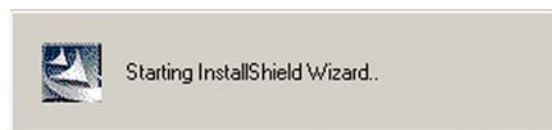

Figure 6-22: AC`97 Audio Driver Install Shield Wizard Starting

Step 5: The Realtek Audio Setup prepares the install shield to guide you through the rest of the setup process. See **Figure 6-24**.

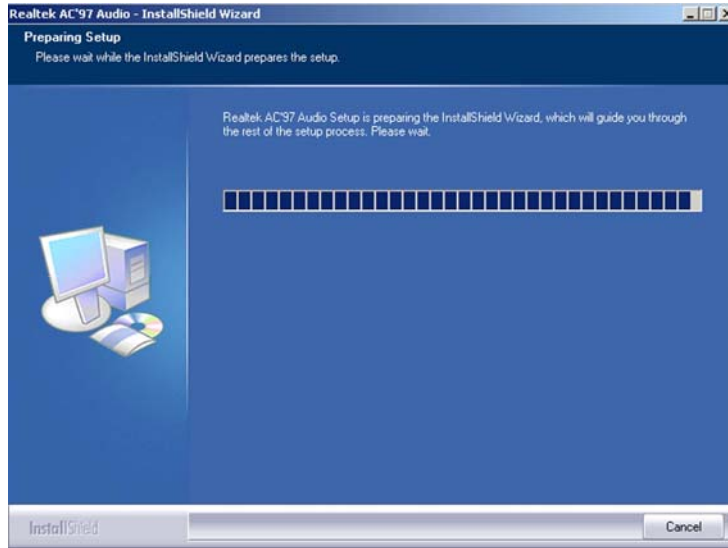

Figure 6-23: AC`97 Audio Driver Setup Preparation

Step 6: After the install shield is prepared, the welcome screen shown in **Figure 6-24** appears. To continue the installation process, click the **“NEXT”** button. The install shield starts to configure the new software as shown in **Figure 6-24**.

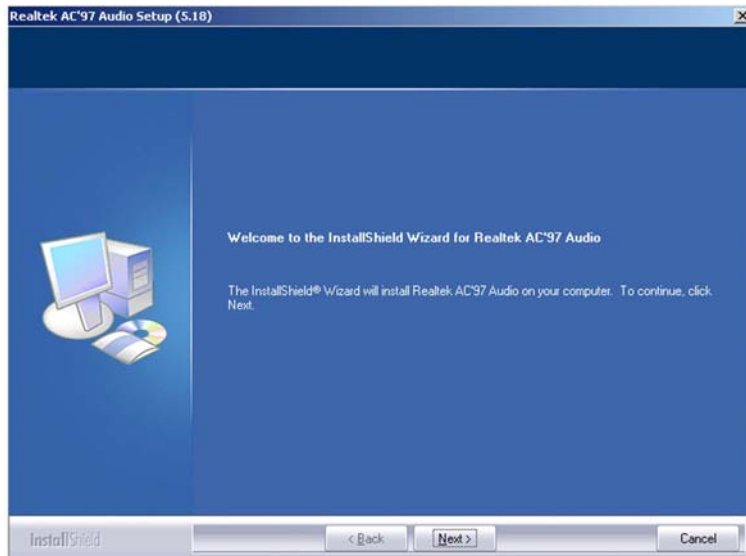

Figure 6-24: AC`97 Audio Driver Welcome Screen

Step 7: At this stage the **“Digital Signal Not Found”** screen appears (**Figure 6-25**). To continue the installation process, click the **“YES”** button.

PPC-37xx-N270 Panel PC



Figure 6-25: AC`97 Audio Driver Digital Signal

Step 8: After clicking the “YES” button in **Figure 6-25**, the installation of the driver begins (**Figure 6-26**).

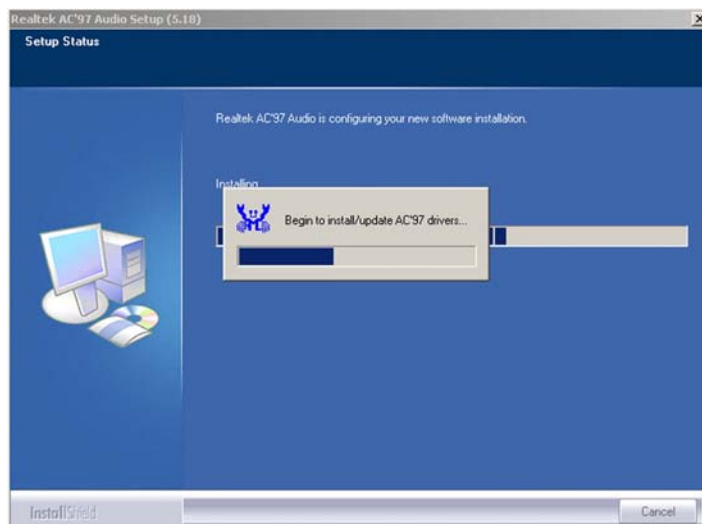

Figure 6-26: AC`97 Audio Driver Installation Begins

Step 9: After the driver installation process is complete, a confirmation screen shown in **Figure 6-27** appears.

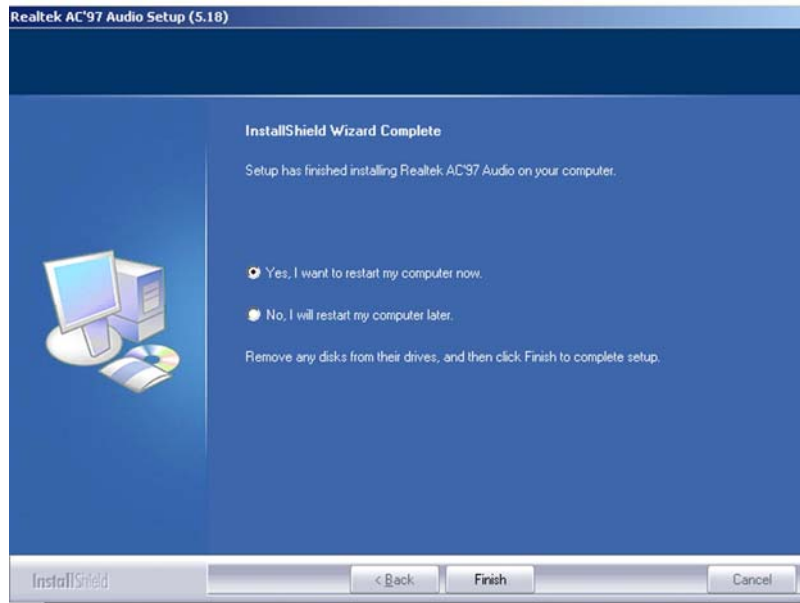

Figure 6-27: AC`97 Audio Driver Installation Complete

Step 10: The confirmation screen shown in **Figure 6-27** allows you to restart the computer immediately after the installation is complete or to restart the computer later. For the settings to take effect the computer must be restarted. Once you have decided when to restart the computer, click the “**FINISH**” button.

6.7 Touchscreen Driver Installation

To install the touchscreen driver, please follow the steps below.

Step 1: Select “**8.TOUCH**” from the list in **Figure 6-1**.

Step 2: Double click the **setup** icon.

Step 3: The Welcome screen in **Figure 6-28** appears. Click **Next** to continue.

PPC-37xx-N270 Panel PC

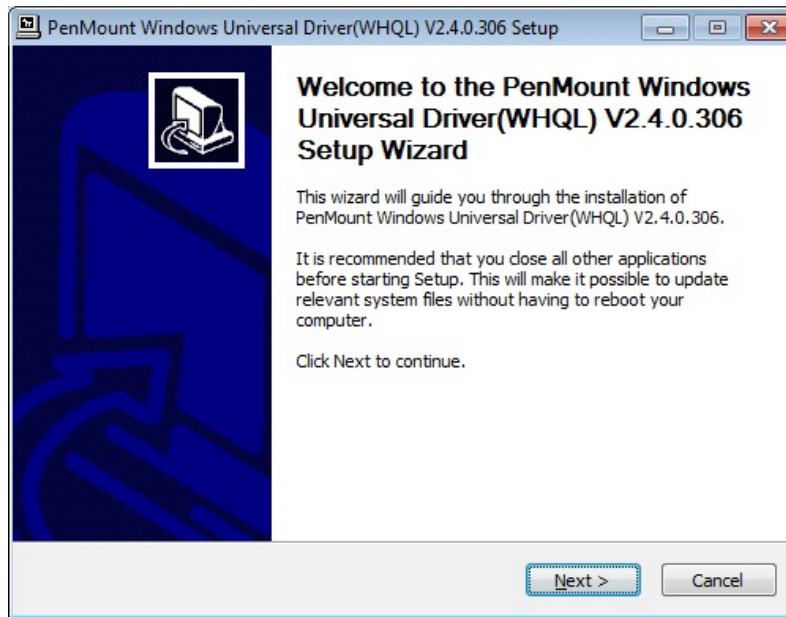

Figure 6-28: Welcome Screen

Step 4: The license agreement in **Figure 6-29** appears.

Step 5: Read the **License Agreement**.

Step 6: Click **I Agree** to continue.

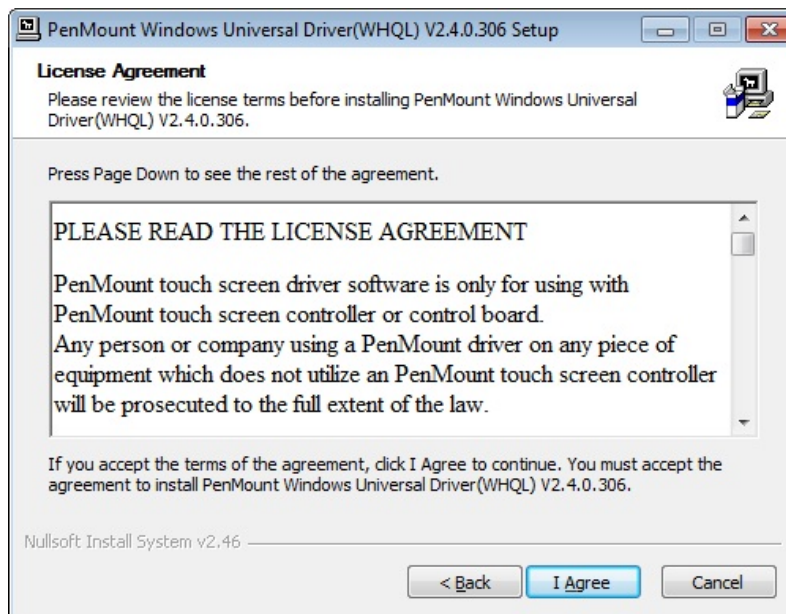

Figure 6-29: Touchscreen Driver License Agreement

Step 7: Select the destination folder where the setup files will be copied to (**Figure 6-30**).

Step 8: Click **Install** to start installation.

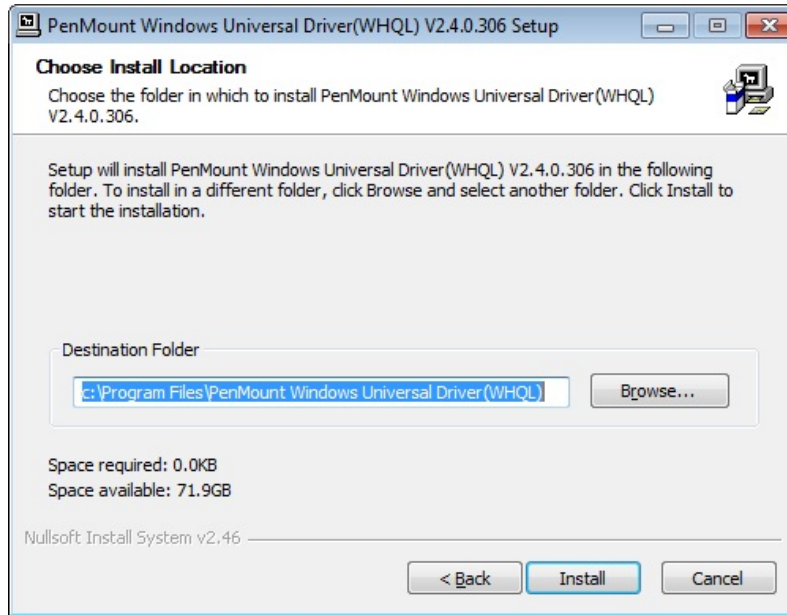

Figure 6-30: Choose Destination Folder

PPC-37xx-N270 Panel PC

Step 9: The installation begins. See **Figure 6-31**.

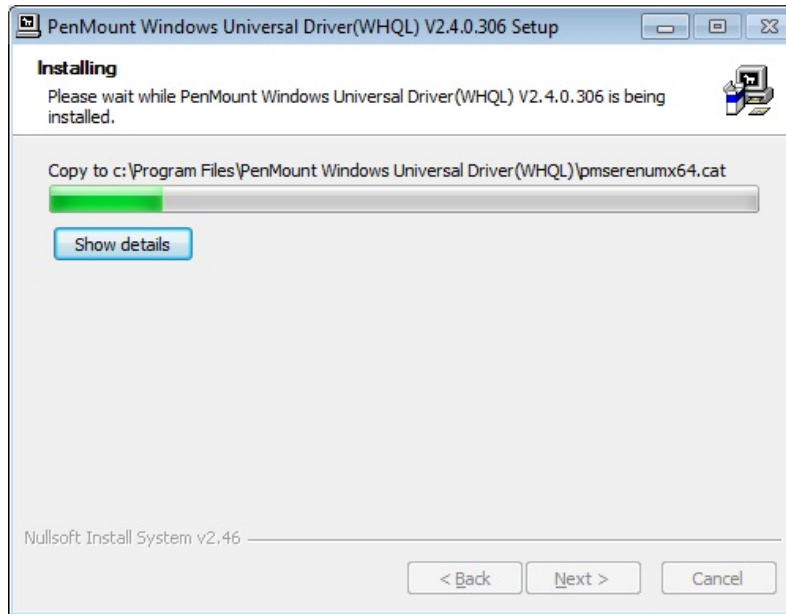

Figure 6-31: Setup Status

Step 10: When the installation is complete, the screen in **Figure 6-32** appears. Click **Finish** to close the setup wizard.

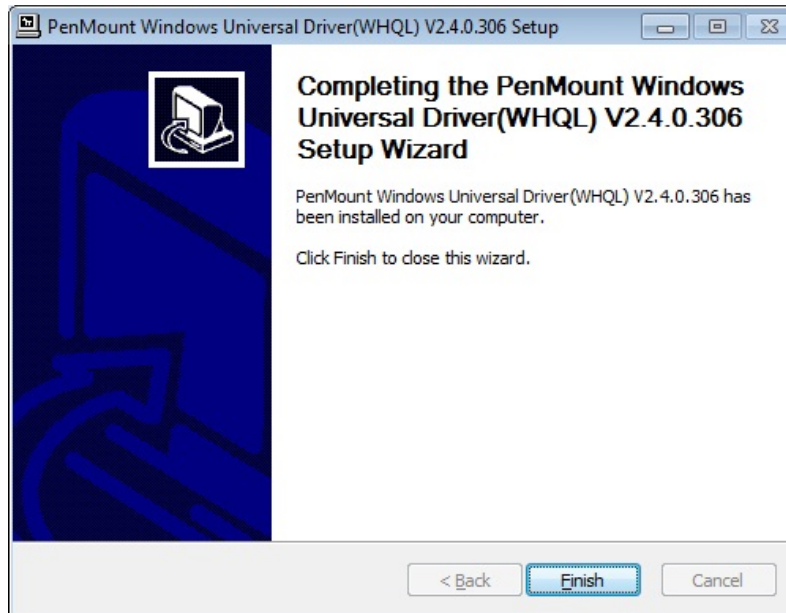



Figure 6-32: Touchscreen Driver Installation Finish Screen

6.7.1 Calibrating the Touchscreen

To calibrate the touchscreen, please follow the steps below.

Step 1: Click the  icon on the Windows taskbar.

Step 2: Click **Control Panel** from the menu (**Figure 6-33**).

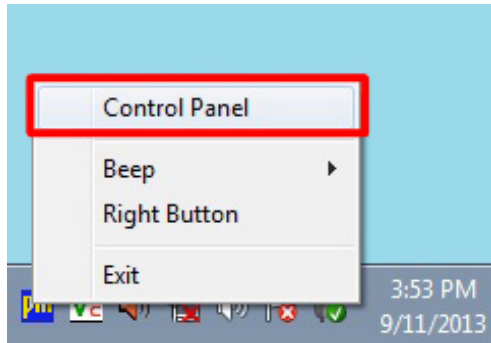

Figure 6-33: Select Control Panel

Step 3: The touchscreen control panel appears (**Figure 6-34**). Click **Configure**.

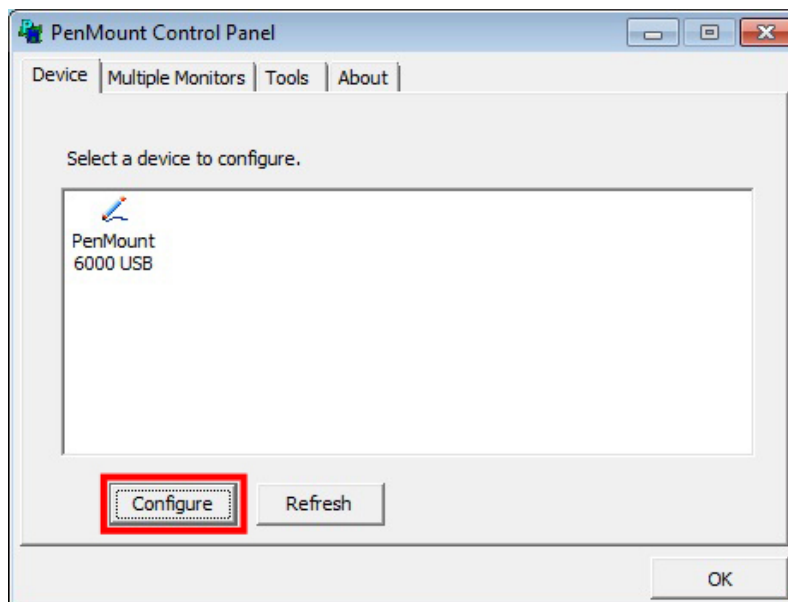

Figure 6-34: Touchscreen Control Panel

PPC-37xx-N270 Panel PC

Step 4: The user can click **Standard Calibration** or **Advanced Calibration** to proceed with standard or advanced calibration.

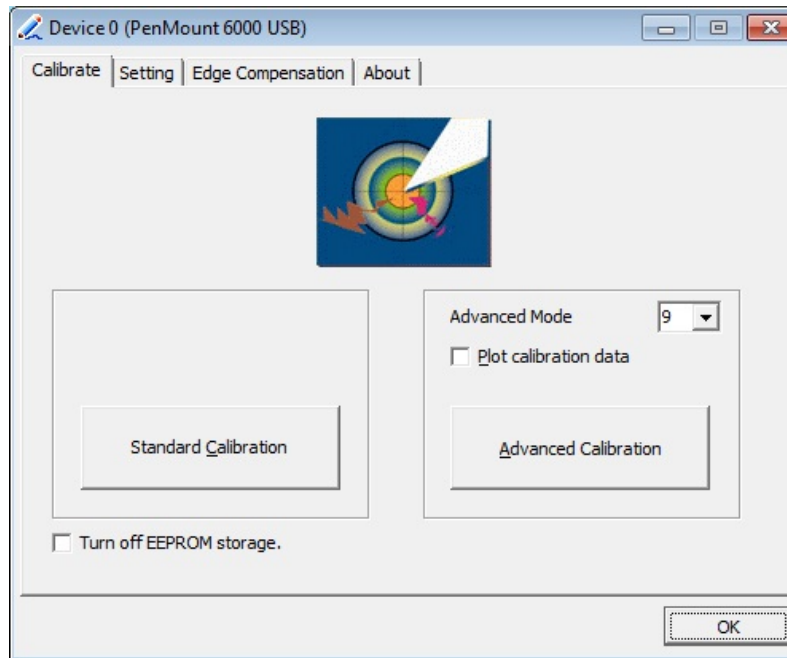

Figure 6-35: Select Calibration Type

Step 5: The calibration window in **Figure 6-36** appears. The user is asked to touch the screen at five specified points, if Standard Calibration is selected. Follow the screen guide to touch and hold each red square in the calibration window until it shows “Lift off to proceed”.

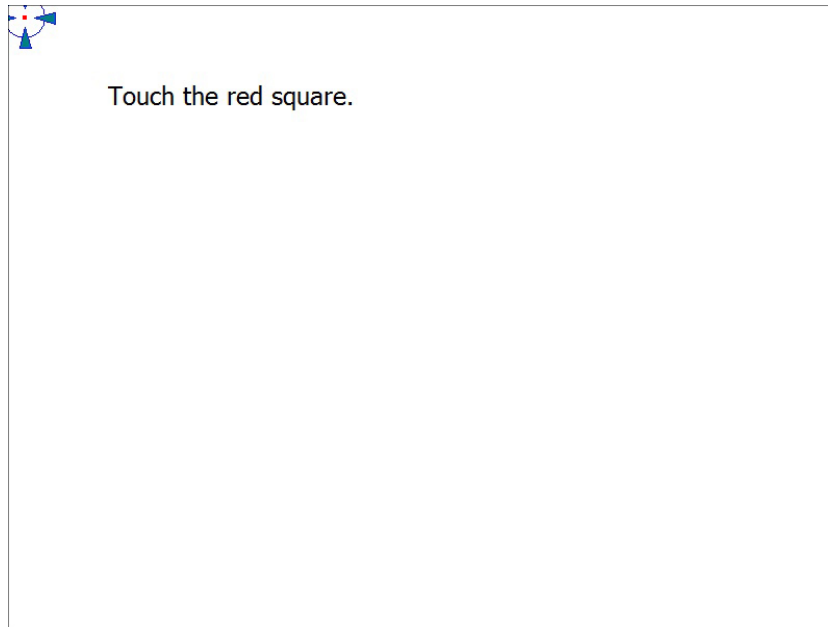

Figure 6-36: Calibration Window

Step 6: When the calibration is complete, the setup returns to the control panel. Click **OK** to exit.

Appendix

A

Safety Precautions

**WARNING:**

The precautions outlined in this chapter should be strictly followed. Failure to follow these precautions may result in permanent damage to the PPC-37xx-N270.

A.1 Safety Precautions

Please follow the safety precautions outlined in the sections that follow:

A.1.1 General Safety Precautions

Please ensure the following safety precautions are adhered to at all times.

- **Follow the electrostatic precautions** outlined below whenever the PPC-37xx-N270 is opened.
- **Make sure the power is turned off and the power cord is disconnected** whenever the PPC-37xx-N270 is being installed, moved or modified.
- **Do not apply voltage levels that exceed the specified voltage range.** Doing so may cause fire and/or an electrical shock.
- **Electric shocks can occur** if the PPC-37xx-N270 chassis is opened when the PPC-37xx-N270 is running.
- **Do not drop or insert any objects** into the ventilation openings of the PPC-37xx-N270.
- **If considerable amounts of dust, water, or fluids enter the PPC-37xx-N270**, turn off the power supply immediately, unplug the power cord, and contact the PPC-37xx-N270 vendor.
- **DO NOT:**
 - Drop the PPC-37xx-N270 against a hard surface.
 - Strike or exert excessive force onto the LCD panel.
 - Touch any of the LCD panels with a sharp object
 - In a site where the ambient temperature exceeds the rated temperature

PPC-37xx-N270 Panel PC

A.1.2 Anti-static Precautions

**WARNING:**

Failure to take ESD precautions during the installation of the PPC-37xx-N270 may result in permanent damage to the PPC-37xx-N270 and severe injury to the user.

Electrostatic discharge (ESD) can cause serious damage to electronic components, including the PPC-37xx-N270. Dry climates are especially susceptible to ESD. It is therefore critical that whenever the PPC-37xx-N270 is opened and any of the electrical components are handled, the following anti-static precautions are strictly adhered to.

- ***Wear an anti-static wristband:*** Wearing a simple anti-static wristband can help to prevent ESD from damaging any electrical component.
- ***Self-grounding:*** Before handling any electrical component, touch any grounded conducting material. During the time the electrical component is handled, frequently touch any conducting materials that are connected to the ground.
- ***Use an anti-static pad:*** When configuring or working with an electrical component, place it on an anti-static pad. This reduces the possibility of ESD damage.
- ***Only handle the edges of the electrical component:*** When handling the electrical component, hold the electrical component by its edges.

A.1.3 Product Disposal

**CAUTION:**

Risk of explosion if battery is replaced by and incorrect type. Only certified engineers should replace the on-board battery.

Dispose of used batteries according to instructions and local regulations.

- Outside the European Union - If you wish to dispose of used electrical and electronic products outside the European Union, please contact your local authority so as to comply with the correct disposal method.
- Within the European Union:

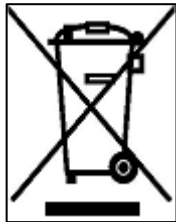

EU-wide legislation, as implemented in each Member State, requires that waste electrical and electronic products carrying the mark (left) must be disposed of separately from normal household waste. This includes monitors and electrical accessories, such as signal cables or power cords.

When you need to dispose of your display products, please follow the guidance of your local authority, or ask the shop where you purchased the product. The mark on electrical and electronic products only applies to the current European Union Member States.

Please follow the national guidelines for electrical and electronic product disposal.

A.2 Maintenance and Cleaning Precautions

When maintaining or cleaning the PPC-37xx-N270, please follow the guidelines below.

A.2.1 Maintenance and Cleaning

Prior to cleaning any part or component of the PPC-37xx-N270, please read the details below.

PPC-37xx-N270 Panel PC

- Except for the LCD panel, never spray or squirt liquids directly onto any other components. To clean the LCD panel, gently wipe it with a piece of soft dry cloth or a slightly moistened cloth.
- The interior of the PPC-37xx-N270 does not require cleaning. Keep fluids away from the PPC-37xx-N270 interior.
- Be cautious of all small removable components when vacuuming the PPC-37xx-N270.
- Turn the PPC-37xx-N270 off before cleaning the PPC-37xx-N270.
- Never drop any objects or liquids through the openings of the PPC-37xx-N270.
- Be cautious of any possible allergic reactions to solvents or chemicals used when cleaning the PPC-37xx-N270.
- Avoid eating, drinking and smoking within vicinity of the PPC-37xx-N270.

A.2.2 Cleaning Tools

Some components in the PPC-37xx-N270 may only be cleaned using a product specifically designed for the purpose. In such case, the product will be explicitly mentioned in the cleaning tips. Below is a list of items to use when cleaning the PPC-37xx-N270.

- **Cloth** – Although paper towels or tissues can be used, a soft, clean piece of cloth is recommended when cleaning the PPC-37xx-N270.
- **Water or rubbing alcohol** – A cloth moistened with water or rubbing alcohol can be used to clean the PPC-37xx-N270.
- **Using solvents** – The use of solvents is not recommended when cleaning the PPC-37xx-N270 as they may damage the plastic parts.
- **Vacuum cleaner** – Using a vacuum specifically designed for computers is one of the best methods of cleaning the PPC-37xx-N270. Dust and dirt can restrict the airflow in the PPC-37xx-N270 and cause its circuitry to corrode.
- **Cotton swabs** - Cotton swabs moistened with rubbing alcohol or water are excellent tools for wiping hard to reach areas.
- **Foam swabs** - Whenever possible, it is best to use lint free swabs such as foam swabs for cleaning.

Appendix

B

BIOS Options

PPC-37xx-N270 Panel PC

Below is a list of BIOS configuration options in the BIOS chapter.

System Overview	65
System Time [xx:xx:xx]	66
System Date [xx/xx/xx]	66
ATA/IDE Configurations [Compatible]	69
Legacy IDE Channels [PATA Pri, SATA Sec]	69
IDE Master and IDE Slave	70
Auto-Detected Drive Parameters	71
Type [Auto]	72
ZIP	72
LS-120	72
LBA/Large Mode [Auto]	72
Block (Multi Sector Transfer) [Auto]	73
PIO Mode [Auto]	73
DMA Mode [Auto]	74
S.M.A.R.T [Auto]	75
32Bit Data Transfer [Enabled]	75
Parallel Port Address [Disabled]	76
Parallel Port Mode [Normal]	76
Parallel Port IRQ [IRQ7]	77
Serial Port1 Address [3F8/IRQ4]	77
Serial Port1 Mode [Normal]	77
Serial Port2 Address [2F8/IRQ3]	78
Serial Port2 Mode [Normal]	78
Serial Port3 Address [3E8]	78
Serial Port3 IRQ [11]	79
Serial Port4 Address [2E8]	79
Serial Port4 IRQ [10]	79
CPU FAN Mode Setting [Full On Mode]	80
CPU Temp. Limit of OFF [000]	81
CPU Temp. Limit of Start [020]	81
CPU Fan Start PWM [070]	82
Slope PWM [0.5 PWM]	82
Suspend Mode [S1(POS)]	84

Restore on AC Power Loss [Last State]	85
Power Button Mode [On/Off].....	85
Resume on Keyboard/Mouse [Disabled]	86
Resume on Ring [Disabled]	86
Resume on PCI-Express WAKE# [Enabled].....	86
Resume On RTC Alarm [Disabled].....	87
RTC Alarm Date (Days).....	87
System Time	87
Remote Access [Disabled].....	88
Serial Port Number	88
Serial Port Mode.....	88
Flow Control	88
Redirection after BIOS POST.....	88
Terminal Type.....	88
VT-UTF8 Combo Key Support	89
Serial Port Number [COM1].....	89
Base Address, IRQ [2F8h,3].....	89
Serial Port Mode [115200 8,n,1].....	89
Flow Control [None].....	90
Redirection After BIOS POST [Always]	90
Terminal Type [ANSI].....	90
VT-UTF8 Combo Key Support [Disabled].....	90
Sredir Memory Display Delay [Disabled].....	91
USB Functions [Enabled].....	92
USB 2.0 Controller [Enabled].....	92
USB2.0 Controller Mode [HiSpeed].....	92
Legacy USB Support [Enabled].....	93
IRQ# [Available].....	94
DMA Channel# [Available]	95
Reserved Memory Size [Disabled]	95
Quick Boot [Enabled]	97
Quiet Boot [Disabled]	97
AddOn ROM Display Mode [Force BIOS]	98
Bootup Num-Lock [Off]	98
Boot From LAN Support [Disabled]	98

PPC-37xx-N270 Panel PC

Change Supervisor Password	100
Change User Password	100
Memory Hole [Disabled]	102
Internal Graphics Mode Select [Enable, 8MB]	103
DVMT Mode Select [DVMT Mode]	103
DVMT/FIXED Memory	103
Boot Display Device [CRT]	104
LVDS Panel Type	104
LCD Brightness Control	104
TV Standard	104
Audio Controller [All Disabled]	105
Save Changes and Exit	106
Discard Changes and Exit	107
Discard Changes	107
Load Optimal Defaults	107
Load Failsafe Defaults	107

Appendix

C

Watchdog Timer

**NOTE:**

The following discussion applies to DOS environment. IEI support is contacted or the IEI website visited for specific drivers for more sophisticated operating systems, e.g., Windows and Linux.

The Watchdog Timer is provided to ensure that standalone systems can always recover from catastrophic conditions that cause the CPU to crash. This condition may have occurred by external EMIs or a software bug. When the CPU stops working correctly, Watchdog Timer either performs a hardware reset (cold boot) or a Non-Maskable Interrupt (NMI) to bring the system back to a known state.

A BIOS function call (INT 15H) is used to control the Watchdog Timer.

INT 15H:

AH – 6FH Sub-function:	
AL – 2:	Sets the Watchdog Timer's period.
BL:	Time-out value (Its unit-second is dependent on the item "Watchdog Timer unit select" in CMOS setup).

Table C-1: AH-6FH Sub-function

Call sub-function 2 to set the time-out period of Watchdog Timer first. If the time-out value is not zero, the Watchdog Timer starts counting down. When the timer value reaches zero, the system resets. To ensure that this reset condition does not occur, calling sub-function 2 must periodically refresh the Watchdog Timer. However, the watchdog timer is disabled if the time-out value is set to zero.

A tolerance of at least 10% must be maintained to avoid unknown routines within the operating system (DOS), such as disk I/O that can be very time-consuming.

**NOTE:**

When exiting a program it is necessary to disable the Watchdog Timer, otherwise the system resets.

EXAMPLE PROGRAM:

```
; INITIAL TIMER PERIOD COUNTER
```

```
;
```

```
W_LOOP:
```

```
;
```

```
    MOV     AX, 6F02H      ;setting the time-out value  
    MOV     BL, 30         ;time-out value is 48 seconds  
    INT     15H
```

```
;
```

```
; ADD THE APPLICATION PROGRAM HERE
```

```
;
```

```
    CMP     EXIT_AP, 1     ;is the application over?  
    JNE     W_LOOP        ;No, restart the application
```

```
    MOV     AX, 6F02H      ;disable Watchdog Timer  
    MOV     BL, 0         ;  
    INT     15H
```

```
;
```

```
; EXIT ;
```

Appendix

D

Hazardous Materials Disclosure

D.1 Hazardous Materials Disclosure Table for IPB Products Certified as RoHS Compliant Under 2002/95/EC Without Mercury

The details provided in this appendix are to ensure that the product is compliant with the Peoples Republic of China (China) RoHS standards. The table below acknowledges the presences of small quantities of certain materials in the product, and is applicable to China RoHS only.

A label will be placed on each product to indicate the estimated “Environmentally Friendly Use Period” (EFUP). This is an estimate of the number of years that these substances would “not leak out or undergo abrupt change.” This product may contain replaceable sub-assemblies/components which have a shorter EFUP such as batteries and lamps. These components will be separately marked.

Please refer to the table on the next page.

PPC-37xx-N270 Panel PC

Part Name	Toxic or Hazardous Substances and Elements					
	Lead (Pb)	Mercury (Hg)	Cadmium (Cd)	Hexavalent Chromium (CR(VI))	Polybrominated Biphenyls (PBB)	Polybrominated Diphenyl Ethers (PBDE)
Housing	<input type="radio"/>	<input type="radio"/>	<input type="radio"/>	<input type="radio"/>	<input type="radio"/>	<input type="radio"/>
Display	<input type="radio"/>	<input type="radio"/>	<input type="radio"/>	<input type="radio"/>	<input type="radio"/>	<input type="radio"/>
Printed Circuit Board	<input type="radio"/>	<input type="radio"/>	<input type="radio"/>	<input type="radio"/>	<input type="radio"/>	<input type="radio"/>
Metal Fasteners	<input type="radio"/>	<input type="radio"/>	<input type="radio"/>	<input type="radio"/>	<input type="radio"/>	<input type="radio"/>
Cable Assembly	<input type="radio"/>	<input type="radio"/>	<input type="radio"/>	<input type="radio"/>	<input type="radio"/>	<input type="radio"/>
Fan Assembly	<input type="radio"/>	<input type="radio"/>	<input type="radio"/>	<input type="radio"/>	<input type="radio"/>	<input type="radio"/>
Power Supply Assemblies	<input type="radio"/>	<input type="radio"/>	<input type="radio"/>	<input type="radio"/>	<input type="radio"/>	<input type="radio"/>
Battery	<input type="radio"/>	<input type="radio"/>	<input type="radio"/>	<input type="radio"/>	<input type="radio"/>	<input type="radio"/>

O: This toxic or hazardous substance is contained in all of the homogeneous materials for the part is below the limit requirement in SJ/T11363-2006

X: This toxic or hazardous substance is contained in at least one of the homogeneous materials for this part is above the limit requirement in SJ/T11363-2006

此附件旨在确保本产品符合中国 RoHS 标准。以下表格标示此产品中某有毒物质的含量符合中国 RoHS 标准规定的限量要求。

本产品上会附有“环境友好使用期限”的标签，此期限是估算这些物质“不会有泄漏或突变”的年限。本产品可能包含有较短的环境友好使用期限的可替换元件，像是电池或灯管，这些元件将会单独标示出来。

部件名称	有毒有害物质或元素					
	铅 (Pb)	汞 (Hg)	镉 (Cd)	六价铬 (CR(VI))	多溴联苯 (PBB)	多溴二苯 醚 (PBDE)
壳体	○	○	○	○	○	○
显示	○	○	○	○	○	○
印刷电路板	○	○	○	○	○	○
金属螺帽	○	○	○	○	○	○
电缆组装	○	○	○	○	○	○
风扇组装	○	○	○	○	○	○
电力供应组装	○	○	○	○	○	○
电池	○	○	○	○	○	○